

AMTEC®

Precision thread inserts
for plastic parts and equipment for installation

BÖLLHOFF



AMTEC® thread inserts

Contents



	Page
AMTEC® – highly wear-resistant thread inserts for plastic parts	3
The advantages – an overview	3
Selection guide for AMTEC® thread inserts	4
Selection guide for installation methods	5

Variations



Installation methods – thermal installation

Thread inserts for thermal installation		
	HITSERT® 2	6 – 7
	Technical data	9 – 10
Thread inserts for thermal installation, tapping and cold insertion		
	HITSERT® 3	8
	Technical data	9 – 10
Thread inserts for ultrasonic installation		
	SONICSERT®	11 – 12
	Technical data	13 – 14
	Installation methods	15
	Installation machines	18 – 18

Installation methods – self-tapping insertion

Thread inserts for self-tapping insertion		
	QUICKSERT®	19 – 20
	Technical data	21 – 22
	QUICKSERT® Hex	23
	Technical data	23
	QUICKSERT® plus	24
	Technical data	25 – 26
	Installation tools	27 – 29

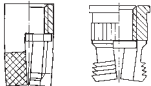
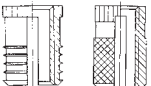
Installation methods – expansion anchoring

Thread inserts for expansion anchoring		
	EXPANSIONSERT 1 and 2	30 – 32
	Technical data	30 – 32
	SPREDSERT® 1 and 2	33 – 34
	Technical data	35 – 36
	SPREDSERT® with retaining flange	37
	Technical data	37
	QUICKSERT® type 1230	38
	Technical data	38
	Installation tools	39 – 40

Fields and examples of application	41 – 42
------------------------------------	---------

Product news	43
--------------	----

AMTEC® Highly wear-resistant thread inserts for plastic parts

Under the name AMTEC®, Böllhoff offers thread inserts and the corresponding assembly system for aftermoulding technology. These thread inserts are especially designed for after-moulding insertion. The result are wear-free, high-strength threads in your high-quality plastic parts.

They are suitable for installation in mouldings of thermoset, thermoplastic or reactive resin materials (also filled or foamed).

There are the following different installation methods:

- Thermal installation – hot plate welding, electromagnetic resistance welding
- Ultrasonic welding
- Expansion anchoring
- Self-tapping insertion
- Pressing-in

For the most efficient installation method, we offer:

- Manual installation tools
- Semi-automatic installation tools
- Automatic machines: Ranging from multiple installation for large-scale production to freely programmable CNC-controlled installation machines for frequently changing components.

Feel free to contact us for customised thread inserts and installation devices. We offer a free CAD download service.

Download 3-D models of the AMTEC® products and directly integrate them into your designs (www.boellhoff.com/cad_gb).

The advantages – an overview

- Reduced injection cycles, automatic injection moulding without insertion of metal parts
- No risk of damage to the injection mould from falling out metal parts
- No stress cracks resulting from hardly controllable shrinkage around the metal part
- Advantages over self-tapping screws since the joint can be detached as often as required without damaging the thread
- Safe, tension-free anchorage with high pull-out and torque values
- Reduction in manufacturing costs for the plastic parts and increased quality of your products
- Low-maintenance machines in combination with innovative control concepts (service expenditure reduced to a minimum)

Selection guide for AMTEC® thread inserts

Requirements Specifications	HITSERT® 2	HITSERT® 3	SONICSERT®	QUICKSERT® plus	QUICKSERT® QUICK-SERT® Hex self-tapping	QUICKSERT® type 1230 expansion	EXPANSION-SERT 1	EXPANSION-SERT 2	SPREDSERT® type 1/type 2 SPREDSERT® with retaining flange
Suitability for different constr. materials									
- Thermoplastics	++	++	++	++	+	+	0	exception	type 1/withret. flange+
- Thermosets	--	-	--	--	++	+	+	--	type 2/withret. flange+
- Foams	--	--	--	-	0	-	--	+	--
- Elastomers	--	--	--	-	0	--	--	+	--
Minimum installation effort (machine technology)	Thermal installation machine (min. quantities with soldering gun)	"soldering gun" screwdriver toggle press	ultrasonic welding machine	manual installation tool screwdriver	manual installation tool screwdriver	spindle lifting tool (possibly press)	manual installation mandrel	manual installation mandrel	manual installation mandrel
Recommended wall thicknesses (comparable quality: 1 = low, 4 = high)	1	1	2	2	3	4	4	4	3
Fitting values in equal thermoplastics	100 %	100 % for thermal installation and tapping insertion, 70 % for pressing-in	80 %	110 %	120 %	100 %	60 %	-	50 %
Special requirements:									
- Tightness	with O-ring (implemented)	yes	with O-ring (possible)	no	no	-	no	no	no
- Bolt thread	yes		yes	no	no	-	no	no	no
- Through hole	yes	yes	yes	no	no		no	no	no
Others	by taper (8°) - self-centring - low-tension	seal insert, variable installation		chipless embedding		also suitable for light metals	easy installation		cost-effective
This catalogue, on page	6	8	11	19	23	24	30	32	33

! **Remarks regarding "Fitting values in equal thermoplastics":**
Indicated values relate to HITSERT® 2 in PA GF.

-- unsuitable / - limited / 0 satisfactory / + good / ++ very good

Selection guide for installation methods

To meet the high general requirements to connection technology, fasteners and processing systems must be perfectly designed and match perfectly. That is why we, as a specialist in fastening and assembly technology, in the field of embedding thread inserts cooperate with KVT Bielefeld GmbH, Werkering 6, 33609 Bielefeld, Germany, phone + 49 (0)521-9320710, info@kvt-bielefeld.de, the welding specialist.

Installation methods	Possible sizes	Installation time	Materials	Size	Batch sizes	Installation accuracy			Special characteristics
						< 0.05	+/- 0.1	≥ 0.2	
HEW – heat element welding	M 2 – M 8	approx. 3 – 4 seconds (for size M 4)	thermo- plastics, thermo- plastic elastomers	≤ M 3	< 50,000	--	++	++	<ul style="list-style-type: none"> – low-tension – multiple installation possible – well suitable for threaded bolts – easily convertible to other thread insert dimensions
					~ 500,000	--	++	++	
					> 1 Mio.	--	++	++	
					< 50,000	--	++	++	
					~ 500,000	--	++	++	
					> 1 Mio.	--	++	++	
				M 4 – M 6	< 50,000	--	+	+	
					~ 500,000	--	+	+	
					> 1 Mio.	--	+	+	
					< 50,000	++	++	++	
					~ 500,000	++	++	++	
					> 1 Mio.	++	++	++	
ERW – electromagnetic resistance welding	M 1,4 – M 40	approx. 3 seconds (for size M 5)	thermo- plastics, thermo- plastic elastomers	≤ M 3	< 50,000	++	++	++	<ul style="list-style-type: none"> – low-tension – multiple installation possible – especially for inserts < M 2 as well as inserts with sealing rings – single-phase or two-phase process can be selected
					~ 500,000	++	++	++	
					> 1 Mio.	++	++	++	
					< 50,000	++	++	++	
					~ 500,000	++	++	++	
					> 1 Mio.	++	++	++	
				M 4 – M 6	< 50,000	++	++	++	
					~ 500,000	++	++	++	
					> 1 Mio.	++	++	++	
					< 50,000	++	++	++	
					~ 500,000	++	++	++	
					> 1 Mio.	++	++	++	
USW – ultrasonic welding	M 2 – M 6	approx. 3 seconds (for size M 5)	thermo- plastics,	≤ M 3	< 50,000	--	0	++	<ul style="list-style-type: none"> – high noise emission upon installation of metal inserts – considerable abrasion upon installation of metal inserts – unsuitable for threaded bolts – easily convertible to other thread insert dimensions
					~ 500,000	--	0	++	
					> 1 Mio.	--	0	++	
					< 50,000	--	0	++	
					~ 500,000	--	0	++	
					> 1 Mio.	--	0	++	
				M 4 – M 6	< 50,000	--	--	--	
					~ 500,000	--	--	--	
					> 1 Mio.	--	--	--	
					< 50,000	--	--	--	
					~ 500,000	--	--	--	
					> 1 Mio.	--	--	--	

-- unsuitable / - limited / 0 satisfactory / + good / ++ very good

All dimensions in mm.

The versions – thread inserts for thermal installation HITSERT® 2

Installation method thermal installation



The advantages

- Ideal for thermoplastic parts
 - Especially designed for thermal installation
 - Screw-locked and low-tension anchoring
 - High pull-out values
 - Efficient installation due to single-spindle, multiple-spindle or automatic machines with preheating device
- Material: Cu Zn 38 Pb 2 (EU 2000/53 compliant)

Principle



The **HITSERT® 2** thread insert is heated to the melting temperature of the plastic. As a result of the heat transfer upon insertion, the plastic is plasticised for a short time and flows into the undercut of the thread insert. Upon cooling, a low-stress interference is realised.

Installation method self-tapping insertion

Technical data

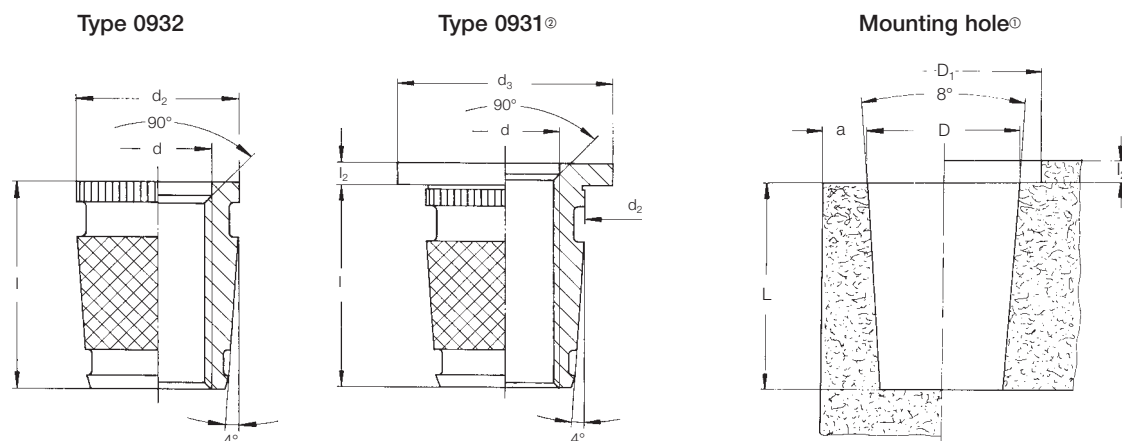

For installation tools and machines, see pages 16 – 18

d	Type 0932 Order No	Type 0931 [Ⓞ] Order No	l	l ₂	d ₂	d ₃	D ^{+0.1}	D ₁	L _{min.}	a _{min.}
M 2	0932 102 0005	0931 102 0056	5.0	0.6	4.1	5.0	3.8	5.2	6.0	1.5
M 2.5	0932 125 0005	0931 125 0056	5.0	0.6	4.1	6.0	3.8	6.2	6.0	1.5
M 3	0932 103 0005	–	5.0	–	4.7	–	4.4	6.2	6.0	1.8
M 3	0932 103 0055	0931 103 0061	5.5	0.6	4.7	6.0	4.4	6.2	6.5	1.8
M 3.5	0932 135 0006	0931 135 0068	6.0	0.8	5.5	7.0	5.2	7.2	7.0	1.8
M 4	0932 104 0006	–	6.0	–	5.9	–	5.8	8.2	7.0	2.0
M 4	0932 104 0075	0931 104 0083	7.5	0.8	5.9	8.0	5.8	8.2	8.5	2.0
M 5	0932 105 0007	–	7.0	–	7.0	–	6.9	8.7	8.0	2.0
M 5	0932 105 0009	0931 105 0010	9.0	1.0	7.0	8.5	6.9	8.7	10.0	2.5
M 6	0932 106 0009	–	9.0	–	8.6	–	8.5	10.2	10.0	2.5
M 6	0932 106 0010	0931 106 0011	10.0	1.0	8.6	10.0	8.5	10.2	11.0	2.5
M 8	0932 108 0012	0931 108 0013	12.0	1.0	11.1	12.0	10.9	12.2	13.0	3.0

Metric ISO thread according to DIN 13-6H.
Technical modifications reserved.
All dimensions in mm.

[Ⓞ] Guide values: depend on moulding material, may have to be changed after setting trials.
[Ⓢ] The flange has a large contact surface and thus reduces surface pressure.
Minimum quantity on request.

Other sizes, special designs and materials on request.

Installation method expansion anchoring

The versions – thread inserts for thermal installation HITSERT® 2

Technical data

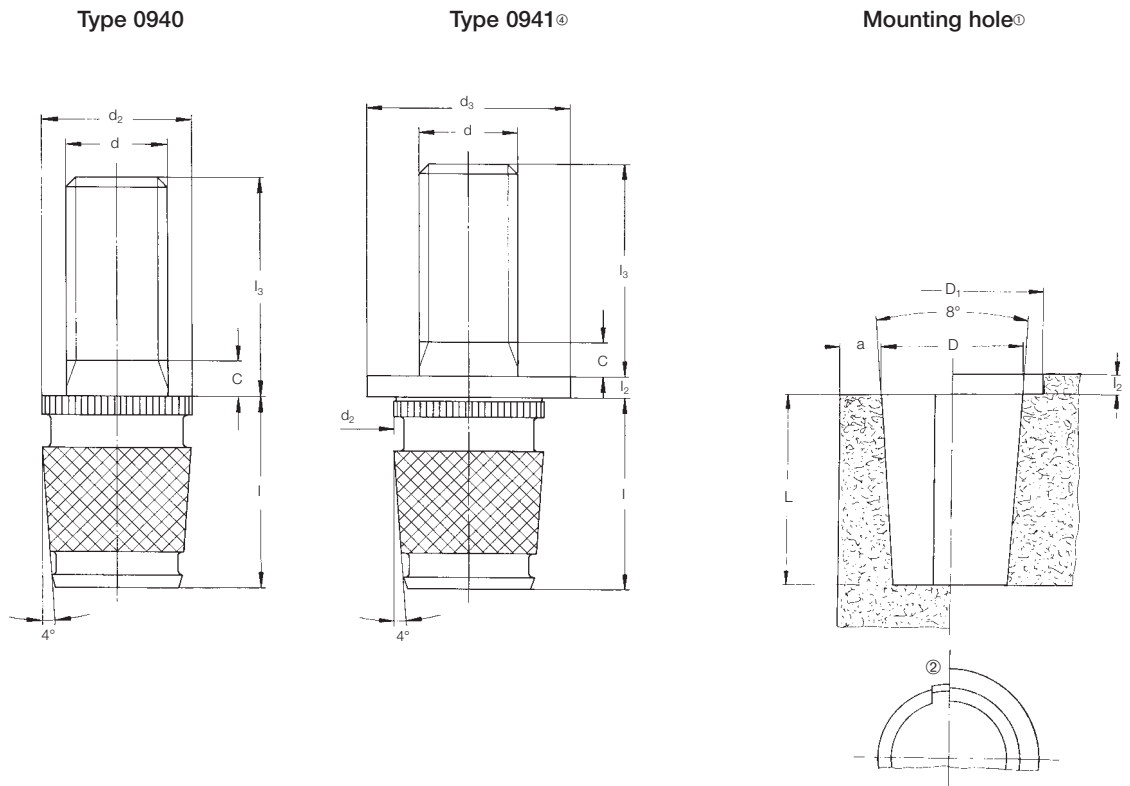

For installation tools and machines, see pages 16 – 18

d	Type 0940® Order No	Type 0941® Order No	l	l ₃	l ₂	d ₂	d ₃ ®	D ^{+0.10}	D ₁	L _{min.}	a _{min.}
M 2.5	0940 125 0005	0941 125 0005	5.0	5.0	0.6	4.1	6.0	3.8	6.2	6.0	1.5
	0940 125 0010	0941 125 0010	5.0	10.0	0.6	4.1	6.0	3.8	6.2	6.0	1.5
M 3	0940 103 0005	0941 103 0005	5.5	5.0	0.6	4.7	6.0	4.4	6.2	6.5	1.8
	0940 103 0010	0941 103 0010	5.5	10.0	0.6	4.7	6.0	4.4	6.2	6.5	1.8
	0940 103 0015	0941 103 0015	5.5	15.0	0.6	4.7	6.0	4.4	6.2	6.5	1.8
M 3.5	0940 135 0005	0941 135 0005	6.0	5.0	0.8	5.5	7.0	5.2	7.2	7.0	1.8
	0940 135 0010	0941 135 0010	6.0	10.0	0.8	5.5	7.0	5.2	7.2	7.0	1.8
	0940 135 0015	0941 135 0015	6.0	15.0	0.8	5.5	7.0	5.2	7.2	7.0	1.8
M 4	0940 104 0005	0941 104 0005	7.5	5.0	0.8	5.9	8.0	5.8	8.2	8.5	2.0
	0940 104 0010	0941 104 0010	7.5	10.0	0.8	5.9	8.0	5.8	8.2	8.5	2.0
	0940 104 0015	0941 104 0015	7.5	15.0	0.8	5.9	8.0	5.8	8.2	8.5	2.0
M 5	0940 105 0010	0941 105 0010	9.0	10.0	1.0	7.0	8.5	6.9	8.7	10.0	2.0
	0940 105 0015	0941 105 0015	9.0	15.0	1.0	7.0	8.5	6.9	8.7	10.0	2.0
	0940 105 0025	0941 105 0025	9.0	25.0	1.0	7.0	8.5	6.9	8.7	10.0	2.0
M 6	0940 106 0010	0941 106 0010	10.0	10.0	1.0	8.6	10.0	8.5	10.2	11.0	2.5
	0940 106 0015	0941 106 0015	10.0	15.0	1.0	8.6	10.0	8.5	10.2	11.0	2.5
	0940 106 0025	0941 106 0025	10.0	25.0	1.0	8.6	10.0	8.5	10.2	11.0	2.5

Metric ISO thread according to DIN 13-6g.
 Technical modifications reserved.
 All dimensions in mm.

- ® Guide values: depend on moulding material, may have to be changed after setting trials.
- ® For blind holes we recommend to provide core pins with ventilation groove.
 Feel free to order our company standard.
- ® Minimum quantity on request, no stock type.
- ® The flange has a large contact surface and thus reduces surface pressure.

Other lengths, special designs and materials on request.

The versions – thread inserts for thermal installation, tapping and cold insertion
HITSERT® 3

Installation method thermal installation



The advantages

- Well-proven 8° taper angle
- Self-centring
- Large contact surface for plastic prior to installation
- Flexible installation due to thermal installation, tapping or cold insertion
- Short installation times
- Milled external contour (low tolerances)
- Efficient seal inserts

Installation method self-tapping insertion

Principle

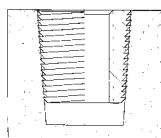

HITSERT® 3 is a tapered universal insert for thermoplastics (thermal installation, tapping and cold insertion).

Owing to its patented external contour (characterised by a fine, self-tapping thread with asymmetric flank profile) **HITSERT® 3** is the first thread insert to be employed for the complete range of well established installation methods.

Our Application Engineering Department helps you to find the perfect installation method for your application (in terms of installation effort and fitting values). You set the priorities.

Installation method expansion anchoring

Technical data

Type 0935

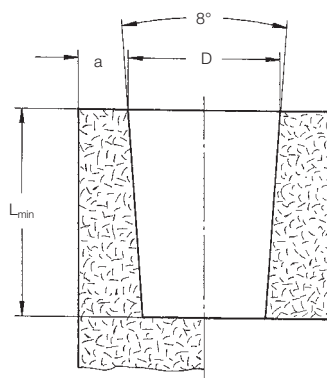
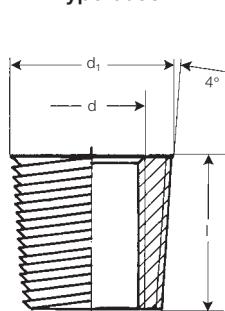

Size	Order No	d ₁ [±]	l	D ^{+0.1*}	L _{min.}	a _{min.}
M 3	0935 1030 005	4.7	5	4.4	6.0	1.8
M 4	0935 1040 075	6.1	7.5	5.8	8.5	2.0
M 5	0935 1050 009	7.3	9	6.9	10.0	2.0
M 6	0935 1060 010	8.9	10	8.5	11.0	2.5

* Guide values: depend on moulding material, may have to be changed after setting trials.
 Minimum quantity on request.
 All dimensions in mm.

German and international patents applied for and granted.

The versions – thread inserts for thermal installation **HITSERT®**

Technical data

Torque values HITSERT® M 3 to M 8

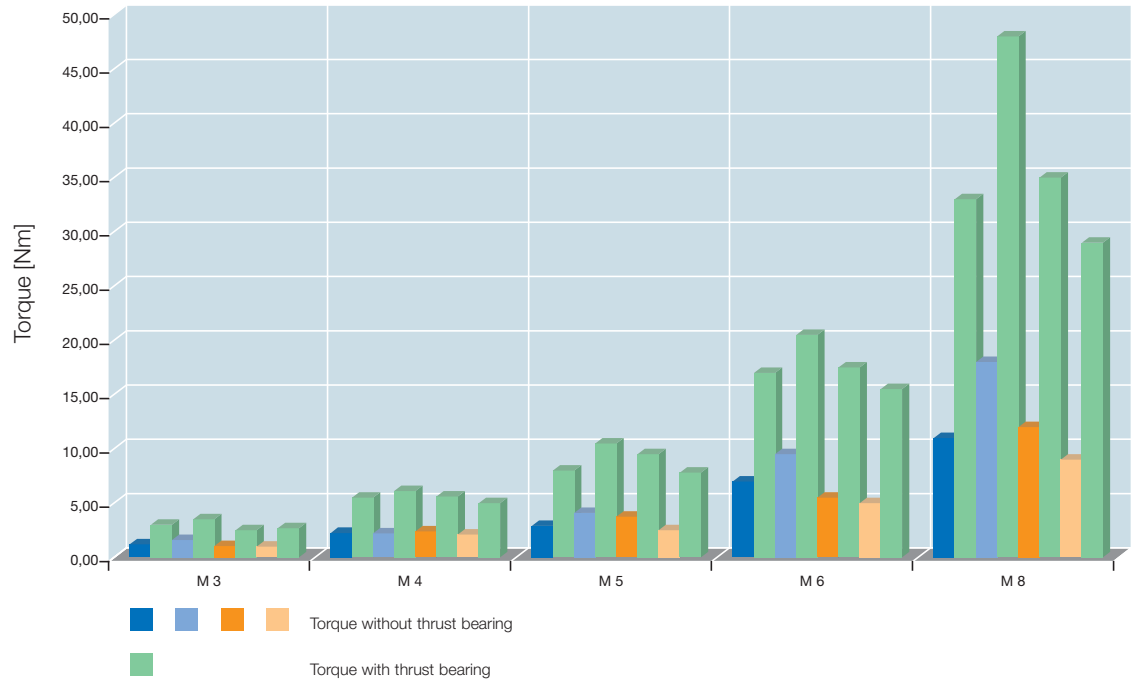

		M 3	M 4	M 5	M 6	M 8
■ ABS	MA [Nm]	1.20	2.25	2.90	7.00	11.00
■ ABS	MR [Nm]	3.00	5.50	8.00	17.00	33.00
■ PC	MA [Nm]	1.60	2.20	4.10	9.50	18.00
■ PC	MR [Nm]	3.50	6.10	10.50	20.50	48.00
■ PA	MA [Nm]	1.05	2.40	3.75	5.50	12.00
■ PA	MR [Nm]	2.50	5.60	9.50	17.50	35.00
■ PE/PP	MA [Nm]	1.00	2.10	2.50	5.00	9.00
■ PE/PP	MR [Nm]	2.70	5.00	7.80	15.50	29.00

All dimensions in mm.

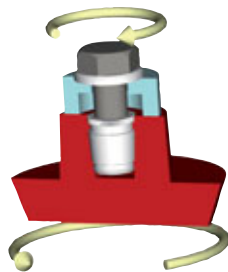

Torque without thrust bearing (MA[Nm])
(jack out)

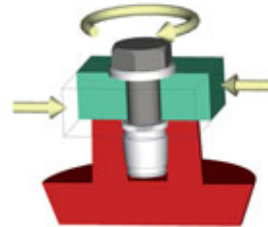

Torque with thrust bearing (MR[Nm])

*The versions – thread inserts for thermal installation **HITSERT®***

Technical data

Pull-out values HITSERT® M 3 to M 8

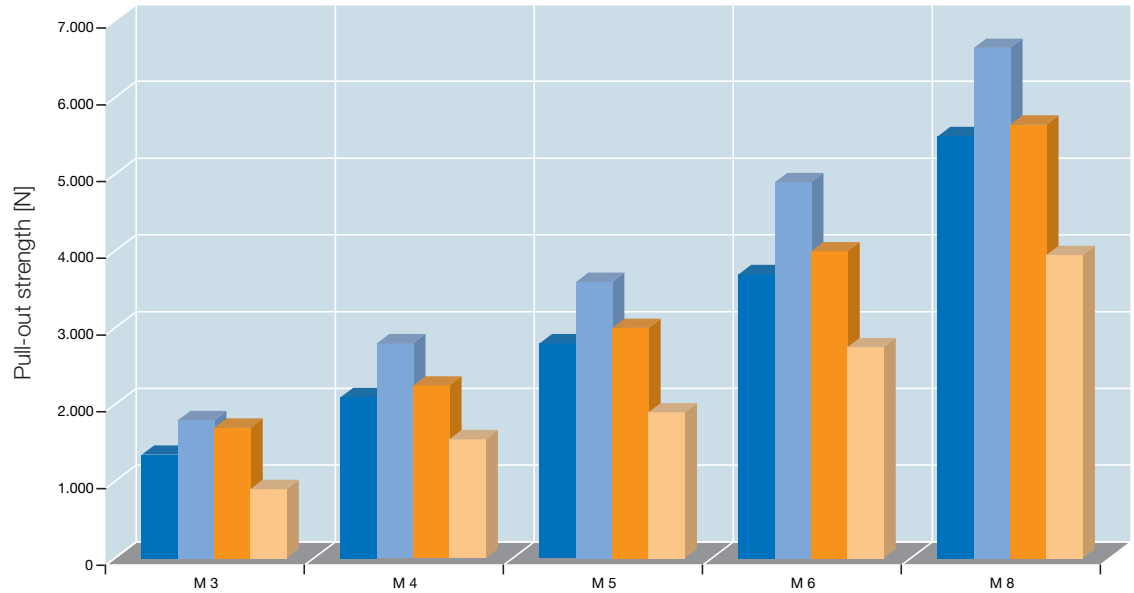

	M 3	M 4	M 5	M 6	M 8
■ ABS FA [N]	1,350	2,100	2,800	3,700	5,500
■ PC FA [N]	1,800	2,800	3,600	4,900	6,650
■ PA FA [N]	1,700	2,250	3,000	4,000	5,650
■ PE/PP FA [N]	900	1,550	1,900	2,750	3,950

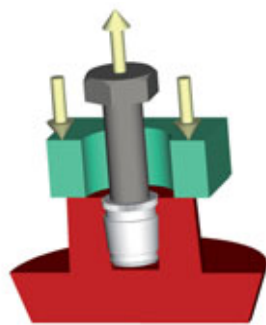

Pull-out strength (FA[N])

Technical notes

Indicated values are guide values. We recommend an installation test for the respective application. To be on the safe side, for fibre-reinforced plastics, the strengths of the non-reinforced material should be assumed. If you use brass thread inserts in plastics susceptible to stress cracks (e.g. polycarbonate), we recommend additional surface treatment of the thread inserts (nickel plating or surface coating as required). Strength values for other thread inserts on request.

The versions – thread inserts for ultrasonic installation SONICSERT®



The advantages

- Suitable for thermoplastic parts
 - Especially designed for ultrasonic installation
 - Screw-locked and low-tension anchoring
 - High pull-out values
 - Type 0730 can be installed from both sides.
- Advantages for automatic feed, since no directional orientation is required.
Material: Cu Zn 38 Pb 2 (EU 2000/53 compliant)

Principle

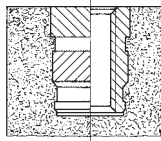

The **SONICSERT®** thread insert is installed with common ultrasonic welders. Upon welding, the plastic material is plasticised by ultrasonic vibrations and flows into the undercuts of the thread insert. Upon cooling, a low-stress interference is realised.

Technical data

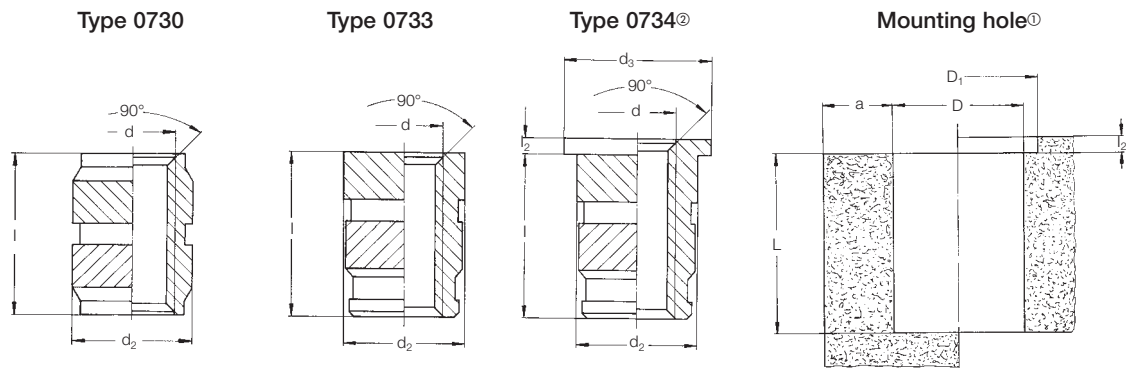

For installation tools and machines, see pages 16 – 18

d	Type 0730 Order No	Type 0733 Order No	Type 0734 [ⓐ] Order No	l	l ₂	d ₂	d ₃ [ⓑ]	D ^{+0.10}	D ₁	L _{min.}	a _{min.}
M 1.2 [ⓐ]	–	–	0734 112 0290	2.9	0.4	2.0	2.6	1.6	2.8	3.3	0.65
M 1.4 [ⓐ]	0730 114 0002	–	–	2.0	–	2.2	–	1.9	–	2.5	0.7
M 1.4 [ⓐ]	–	–	0734 114 0310	3.1	0.4	2.2	2.8	1.8	3	3.5	0.7
M 1.6 [ⓐ]	0730 116 0250	–	–	2.5	–	3.0	–	2.6	–	3.0	0.8
M 1.6 [ⓐ]	–	–	0734 116 0330	3.3	0.4	2.5	2.9	2.1	3.1	3.7	0.8
M 2	0730 102 0004	0733 102 0004	0734 102 0046	4.0	0.6	3.6	5.0	3.2	5.2	4.5	2.0
M 2.5	0730 125 0058	0733 125 0058	0734 125 0064	5.8	0.6	4.6	6.0	4.0	6.2	6.5	2.3
M 3	0730 103 0058	0733 103 0058	0734 103 0064	5.8	0.6	4.6	6.0	4.0	6.2	6.5	2.3
M 3.5	0730 135 0072	0733 135 0072	0734 135 0008	7.2	0.8	5.4	7.0	4.8	7.2	8.0	2.5
M 4	–	0733 104 0072	–	7.2	–	6.3	–	5.6	8.2	8.0	2.5
M 4	0730 104 0082	0733 104 0082	0734 104 0009	8.2	0.8	6.3	8.0	5.6	8.2	9.0	2.5
M 5	–	0733 105 0082	–	8.2	–	7.0	–	6.4	8.7	9.0	2.7
M 5	0730 105 0095	0733 105 0095	0734 105 0105	9.5	1.0	7.0	8.5	6.4	8.7	10.5	2.7
M 6	–	0733 106 0095	–	9.5	–	8.6	–	8.0	10.2	10.5	3.0
M 6	0730 106 0127	0733 106 0127	0734 106 0137	12.7	1.0	8.6	10.0	8.0	10.2	14.0	3.0
M 8	0730 108 0127	0733 108 0127	0734 108 0137	12.7	1.0	10.2	12.0	9.6	12.2	14.0	3.5

Metric ISO thread according to DIN 13-6H.
Technical modifications reserved.
All dimensions in mm.

[ⓐ] Guide values: depend on moulding material, may have to be changed after setting trials.
[ⓑ] The flange has a large contact surface and thus reduces surface pressure.
Minimum quantity on request.
[ⓒ] On request.

Other sizes, special designs and materials on request.

Technical data

Type 0743

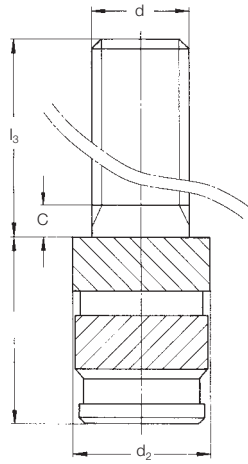

Type 0744®

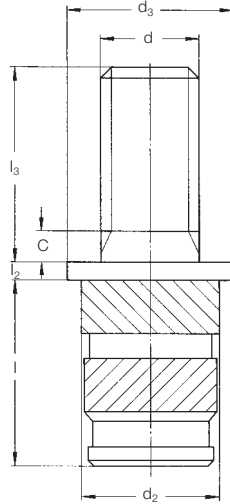

Mounting hole®

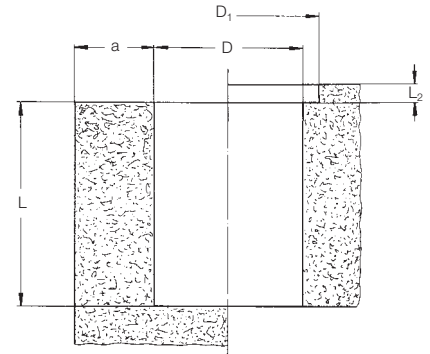

$C_{max} = 3P$

For installation tools and machines, see pages 16 – 18

d	Type 0743® Order No	Type 0744® Order No	l	l ₂ /L ₂	l ₃	d ₂	d ₃ ®	D ^{+0.10}	D ₁	L _{min.}	a _{min.}
M 2	0743 102 0005	0744 102 0005	4.0	0.6	5.0	3.8	5.0	3.2	5.2	4.5	2.0
	0743 102 0010	0744 102 0010	4.0	0.6	10.0	3.8	5.0	3.2	5.2	4.5	2.0
M 2.5	0743 125 0005	0744 125 0005	4.0	0.6	5.0	4.6	5.0	3.2	5.2	4.5	2.0
	0743 125 0010	0744 125 0010	5.8	0.6	10.0	4.6	6.0	4.0	6.2	6.5	2.3
M 3	0743 103 0005	0744 103 0005	5.8	0.6	5.0	4.6	6.0	4.0	6.2	6.5	2.3
	0743 103 0010	0744 103 0010	5.8	0.6	10.0	4.6	6.0	4.0	6.2	6.5	2.3
M 3.5	0743 135 0005	0744 135 0005	7.2	0.8	5.0	5.4	7.0	4.8	7.2	8.0	2.5
	0743 135 0010	0744 135 0010	7.2	0.8	10.0	5.4	7.0	4.8	7.2	8.0	2.5
M 4	0743 104 0005	0744 104 0005	8.2	0.8	5.0	6.3	8.0	5.6	8.2	9.0	2.5
	0743 104 0010	0744 104 0010	8.2	0.8	10.0	6.3	8.0	5.6	8.2	9.0	2.5
M 4	0743 104 0015	0744 104 0015	8.2	0.8	15.0	6.3	8.0	5.6	8.2	9.0	2.5
	0743 105 0010	0744 105 0010	9.5	1.0	10.0	7.0	8.5	6.4	8.7	10.5	2.7
M 5	0743 105 0015	0744 105 0015	9.5	1.0	15.0	7.0	8.5	6.4	8.7	10.5	2.7
	0743 105 0025	0744 105 0025	9.5	1.0	25.0	7.0	8.5	6.4	8.7	10.5	2.7
M 6	0743 106 0010	0744 106 0010	12.7	1.0	10.0	8.6	10.0	8.0	10.2	14.0	3.0
	0743 106 0015	0744 106 0015	12.7	1.0	15.0	8.6	10.0	8.0	10.2	14.0	3.0
M 6	0743 106 0025	0744 106 0025	12.7	1.0	25.0	8.6	10.0	8.0	10.2	14.0	3.0
	0743 108 0010	0744 108 0010	12.7	1.0	10.0	10.0	12.0	9.6	12.2	14.0	3.5
M 8	0743 108 0015	0744 108 0015	12.7	1.0	15.0	10.0	12.0	9.6	12.2	14.0	3.5
	0743 108 0025	0744 108 0025	12.7	1.0	25.0	10.0	12.0	9.6	12.2	14.0	3.5

Metric ISO thread according to DIN 13-6g.
 Technical modifications reserved.
 All dimensions in mm.

® Guide values: depend on moulding material, may have to be changed after setting trials.
 ® Minimum quantity on request, no stock type.
 ® The flange has a large contact surface and thus reduces surface pressure.

Other lengths, special designs and materials on request.

The versions – thread inserts for ultrasonic installation **SONICSERT®**

Technical data

Torque values SONICSERT® M 3 to M 8

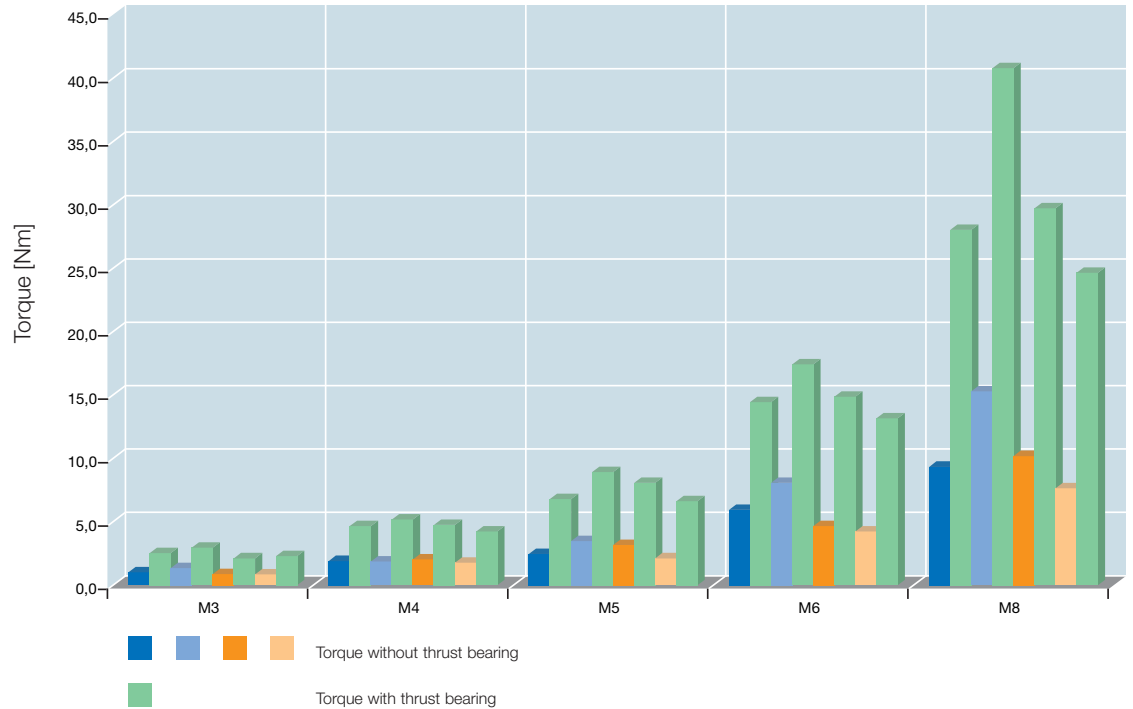

		M 3	M 4	M 5	M 6	M 8
■ ABS	MA [Nm]	1.00	1.90	2.50	6.00	9.40
■ ABS	MR [Nm]	2.60	4.70	6.80	14.50	28.10
■ PC	MA [Nm]	1.40	1.90	3.50	8.40	15.30
■ PC	MR [Nm]	3.00	5.20	8.90	17.40	40.80
■ PA	MA [Nm]	0.90	2.00	3.20	4.70	10.20
■ PA	MR [Nm]	2.10	4.80	8.10	14.90	29.80
■ PE/PP	MA [Nm]	0.90	1.80	2.10	4.30	7.70
■ PE/PP	MR [Nm]	2.30	4.30	6.60	13.20	24.70

All dimensions in mm.

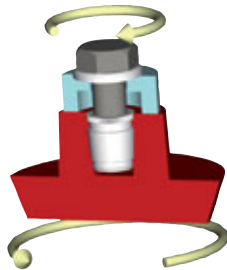

Torque without thrust bearing (MA[Nm])
(jack out)

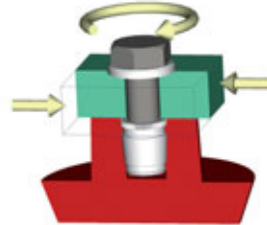

Torque with thrust bearing (MR[Nm])

Installation method thermal installation

Installation method self-tapping insertion

Installation method expansion anchoring

The versions – thread inserts for ultrasonic installation **SONICSERT®**

Technical data

Pull-out values SONICSERT® M 3 to M 8

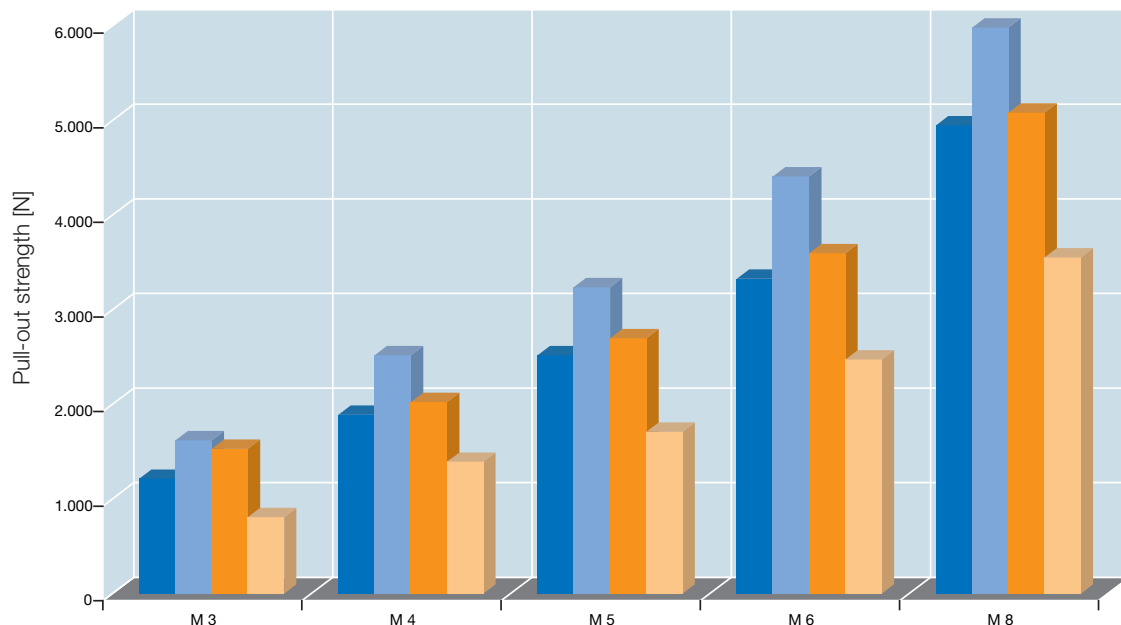

	M 3	M 4	M 5	M 6	M 8
■ ABS FA [N]	1,215	1,890	2,520	3,330	4,950
■ PC FA [N]	1,620	2,520	3,240	4,410	5,985
■ PA FA [N]	1,530	2,025	2,700	3,600	5,085
■ PE/PP FA [N]	810	1,395	1,710	2,475	3,555

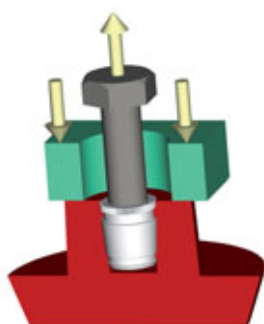

Pull-out strength (FA[N])

Technical notes

Indicated values are guide values. We recommend an installation test for the respective application. To be on the safe side, for fibre-reinforced plastics, the strengths of the non-reinforced material should be assumed. If you use brass thread inserts in plastics susceptible to stress cracks (e.g. polycarbonate), we recommend additional surface treatment of the thread inserts (nickel plating or surface coating as required). Strength values for other thread inserts on request.

Installation method for AMTEC® thread inserts

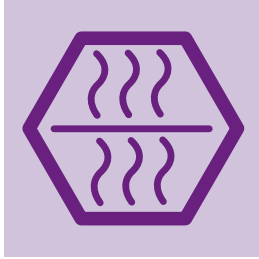

Heat element welding – HEW

Heat element welding is an approved joining process to embed metal thread inserts into thermoplastic mouldings. It is a single-phase process in which contact heat is transferred through the metal insert to the joining zone of the plastic material.

During fusion of the plastic material in the area of the contact surface, joining is carried out. In this process, the plasticised mass is displaced into defined recesses and undercuts. That is how a form-closed joint results.

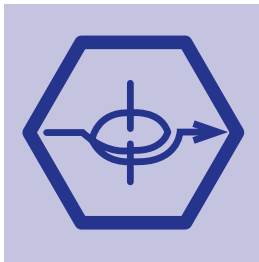

Electromagnetic resistance welding – ERW

ERW is a joining process developed by KVT Bielefeld (Germany) for joints of metal and thermoplastic components. An electromagnetic AC field heats the thread insert without contact and the contact surface of the plastic component is plasticised. In the simultaneous joining process, the fused material is displaced into recesses and interlocks.

Heating of metal elements of any size is executed within a very short time (approx. 2 – 6 sec.). After switching off power supply, accelerated cooling of the melt takes place allowing an installation accuracy of up to 0.05 mm.



Ultrasonic welding – USW

USW is a process which had originally been developed for joining thermoplastic components. Within a very short time, the plastic material is plasticised by boundary-layer friction and vibration absorption of the parts to be joined.

After that, joining is executed. The energy required is generated as alternating voltage in the ultrasonic generator, converted into mechanical vibration (20 – 40 kHz) and then introduced with a sonotrode.

Upon embedding thread inserts (metallic M 2 – M 6) into thermoplastic components, the fused material is displaced into recesses and undercuts.

*KVT thermal installation machines for **AMTEC®** thread inserts*

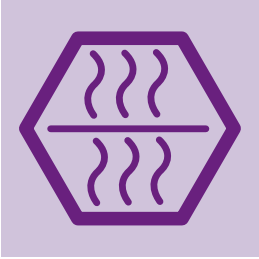

KVT 02 lever-type hand-operated thermal installation tool to embed inserts for limited production volumes

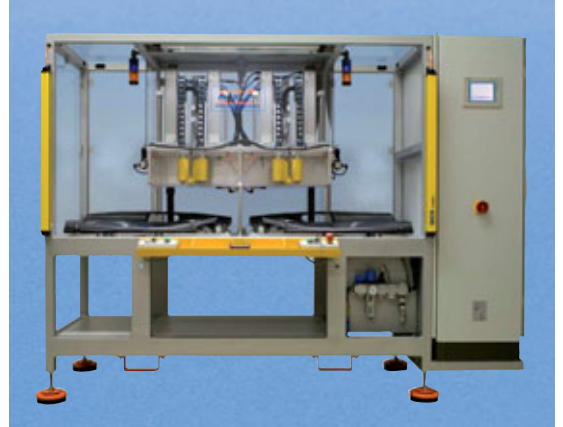

Thermal installation machine in special design for simultaneous embedding of 6 inserts into two car door trims



KVT Basic 5000 DUO thermal installation machine for simultaneous thermal installation of four inserts into two covers of car outside mirrors



KVT Basic 2500 thermal installation machine for simultaneous thermal installation of two inserts into a car charge air pipe

*KVT thermal installation machines for **AMTEC**® thread inserts*

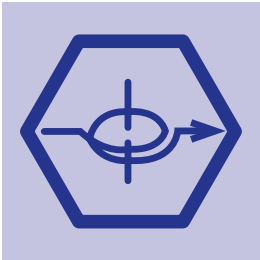

ERW thermal installation machine to embed inserts into parts of a car engine compartment



ERW thermal installation machine to embed four inserts into a boot handle

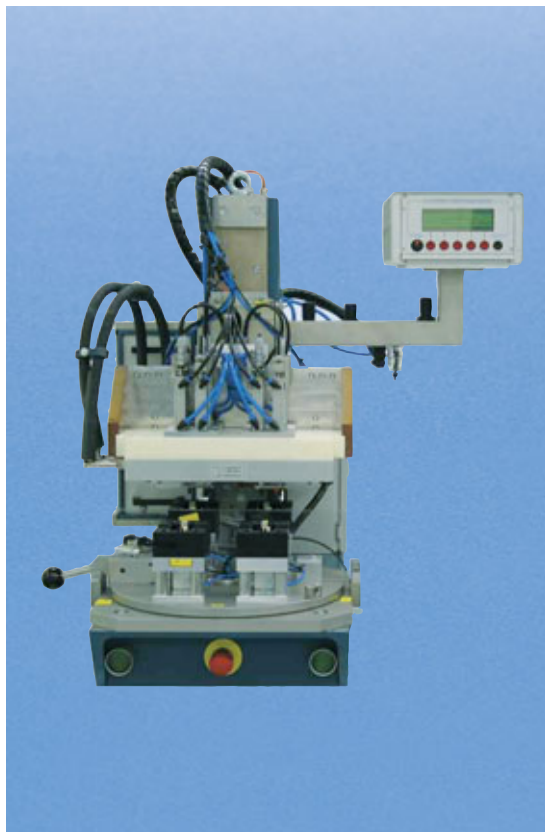

ERW thermal installation machine to embed eight inserts M 1.6 into two mobile phone half shells

KVT thermal installation machines for AMTEC® thread inserts



Ultrasonic welding machine with a working frequency of 20 kHz for ultrasonic riveting or welding or to embed UNITEC® K' in K' (plastic in plastic) inserts. Allows monitoring of all process parameters and their transfer to higher-level systems for production data acquisition.



Ultrasonic welding machine with a working frequency of 35 kHz for ultrasonic riveting or welding or to embed UNITEC® K' in K' (plastic in plastic) inserts.



Sonotrode for integration into standard and special systems



Ultrasonic generator for integration into standard and special systems in digital-analogue design

The versions – thread inserts for self-tapping insertion QUICKSERT®



The advantages

- For brittle and ductile plastics such as unsaturated polyester resins (SMC, ZMC), polyurethane and glass-fibre reinforced thermoplastics
- Universal use
- High-strength and torsion-proof threads
- Optimum assembly characteristics

Material: 1.0718 11 SMnPb 30 zinc coated, chromated or Cu Zn 38 Pb 2 (EU 2000/53 compliant)

Principle

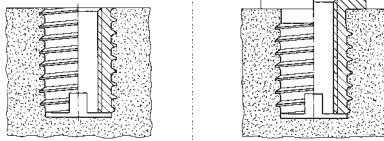

QUICKSERT® consists of a cylindrical basic body with internal thread and a special external thread. The profile of the external thread has an extremely small flank angle and expands asymmetrically towards the thread root. This way, installation at low driving torques is optimised.

Very good tight-fit is achieved with an ideal distribution of load. The bottom part of the bush is provided with a cutting slot. For special requirements, we offer a version with flange. The threaded bush is screwed in with a rotating spindle.

Technical data

Type 1434

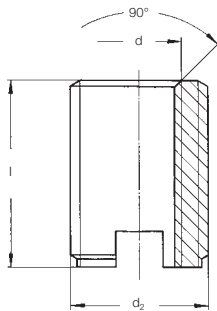

Mounting hole®

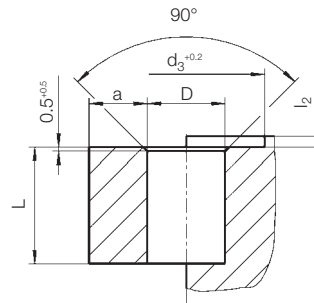

For installation tools and machines, see pages 27 – 29

d	Steel, unhardened Order No	Brass Order No	l	d ₂	D* [Ⓞ]	L _{min.}	a _{min.}
M 3	1434 103 0006	1434 503 0006	6.0	6.0	4.6–5.4	7.0	2.0
M 4	1434 104 0008	1434 504 0008	8.0	7.0	5.6–6.6	9.0	3.0
M 5	1434 105 0010	1434 505 0010	10.0	8.0	6.6–7.6	11.0	4.0
M 6	1434 106 0014	1434 506 0014	14.0	10.0	8.1–9.4	15.0	4.0
M 8	1434 108 0015	1434 508 0015	15.0	12.0	10.1–11.4	16.0	5.0
M 10 [Ⓢ]	1434 110 0018	1434 510 0018	18.0	14.0	12.1–13.4	19.0	5.0

Metric ISO thread according to DIN 13-6H.
Technical modifications reserved.
All dimensions in mm.

Ⓢ Guide values: depend on moulding material, may have to be changed after setting trials.
Ⓞ Minimum quantity on request.
* See table on page 20.

Other sizes and special designs on request.

International patents applied for and granted.

The versions – thread inserts for self-tapping insertion **QUICKSERT®**

Technical data

Type 1433[Ⓢ]
Steel

Brass

Mounting hole[Ⓢ]

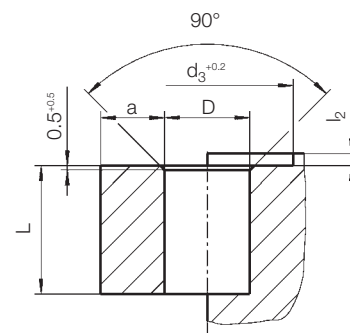
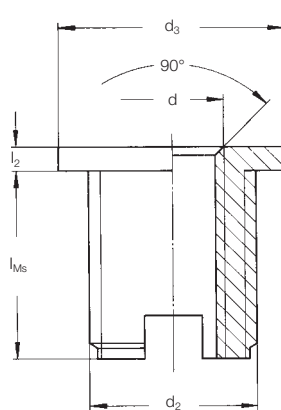
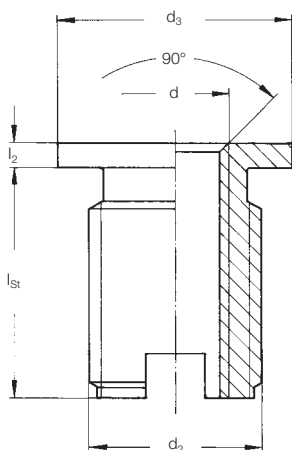

Recommended mounting holes -D- for **QUICKSERT®** in different materials[Ⓢ]

	M 3	M 4	M 5	M 6	M 8	M 10
PE (soft)	4.6	5.6	6.6	8.1	10.1	12.1
PP						
PA 6						
PA 6.6						
PBT						
PE (hard)	4.8	5.8	6.8	8.3	10.3	12.3
PET						
POM						
ASA						
SAN	5.0	6.0	7.0	8.5	10.5	12.5
ABS						
PA 6 GF 30 %						
PBT GF 30 %						
PET GF 30 %	5.2	6.2	7.2	8.7	10.7	12.7
PS						
PVC (hard)						
PA 6.6 GF 30 %						
PC a. PC+GF 30 %	5.4	6.4	7.4	9.0	11.0	13.0
PPO/PPS GF 30 %						
SMC						
ZMC		6.6	7.6	9.4	11.4	13.4
BMT						

Hexagonal flange version on request

For installation tools and machines, see pages 27 – 29

d	Steel, unhardened Order No	Brass Order No	l _{St}	l _{Ms}	l ₂	d ₂	d ₃	D ^{Ⓢ*}	L _{min. St}	L _{min. Ms}	a _{min.}
M 4	1433 104 0105	1433 504 0009	9.5	8.0	1.0	7.0	10.0	5.6– 6.6	10.5	9.0	3.0
M 5	1433 105 0127	1433 505 0112	11.5	10.0	1.2	8.0	11.0	6.6– 7.6	12.5	11.0	4.0
M 6	1433 106 0174	1433 506 0154	16.0	14.0	1.4	10.0	13.0	8.1– 9.4	17.0	15.0	4.0
M 8	1433 108 0184	1433 508 0164	17.0	15.0	1.4	12.0	15.0	10.1–11.4	18.0	16.0	5.0

Metric ISO thread according to DIN 13-6H.
Technical modifications reserved.
All dimensions in mm.

Ⓢ Guide values: depend on moulding material, may have to be changed after setting trials.
Ⓢ The flange has a large contact surface and thus reduces surface pressure.
Ⓢ Hardened on request, no stock type.
* See table above.

Other sizes and special designs on request.
Minimum quantity on request.

International patents applied for and granted.

Installation method thermal installation

Installation method self-tapping insertion

Installation method expansion anchoring

The versions – thread inserts for self-tapping insertion **QUICKSERT®**

Technical data

Torque values QUICKSERT® M 3 to M 8

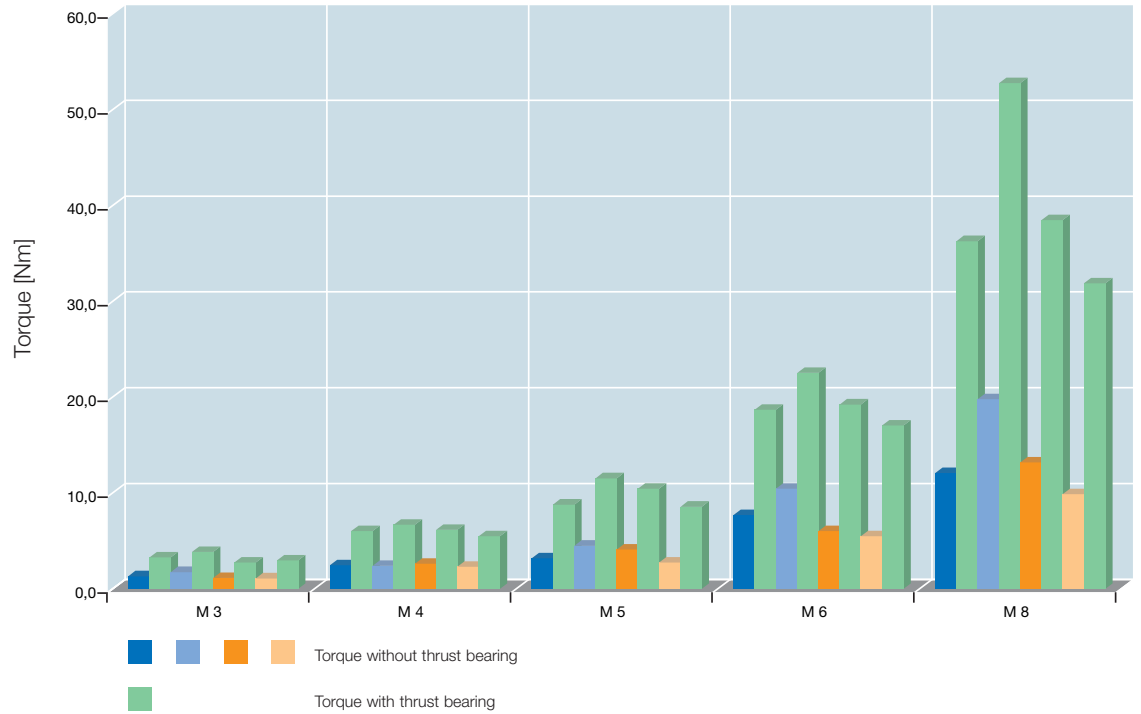

		M 3	M 4	M 5	M 6	M 8
■ ABS	MA [Nm]	1.3	2.5	3.2	7.7	12.1
■ ABS	MR [Nm]	3.3	6.1	8.8	18.7	36.3
■ PC	MA [Nm]	1.8	2.4	4.5	10.5	19.8
■ PC	MR [Nm]	3.9	6.7	11.6	22.6	52.8
■ PA	MA [Nm]	1.2	2.6	4.1	6.1	13.2
■ PA	MR [Nm]	2.8	6.2	10.5	19.3	38.5
■ PE/PP	MA [Nm]	1.1	2.3	2.8	5.5	9.9
■ PE/PP	MR [Nm]	3.0	5.5	8.6	17.1	31.9

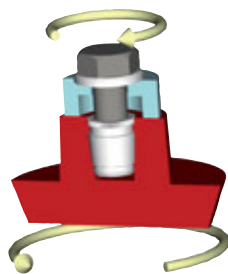

Torque without thrust bearing (MA[Nm])
(jack out)

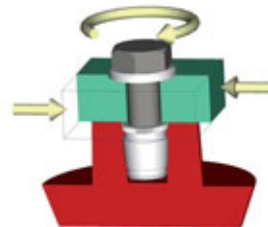

Torque with thrust bearing (MR[Nm])

Installation method thermal installation

Installation method self-tapping insertion

Installation method expansion anchoring

The versions – thread inserts for self-tapping insertion **QUICKSERT®**

Technical data

Pull-out values QUICKSERT® M 3 to M 8

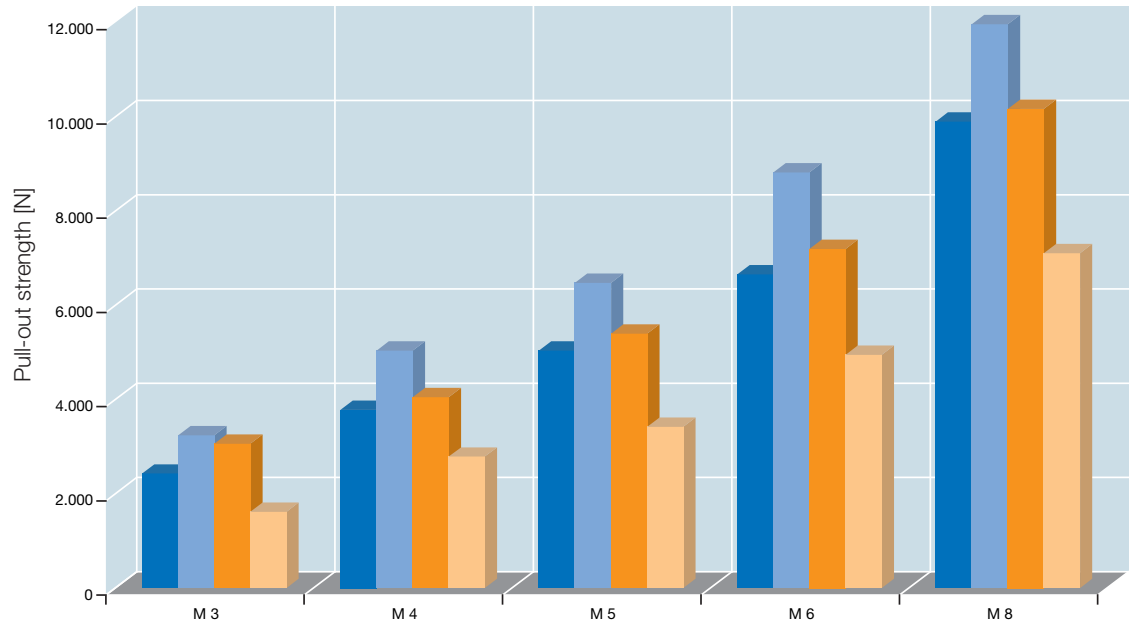

	M 3	M 4	M 5	M 6	M 8
■ ABS FA [N]	2,430	3,780	5,040	6,660	9,900
■ PC FA [N]	3,240	5,040	6,480	8,820	11,970
■ PA FA [N]	3,060	4,050	5,400	7,200	10,170
■ PE/PP FA [N]	1,620	2,790	3,420	4,950	7,110

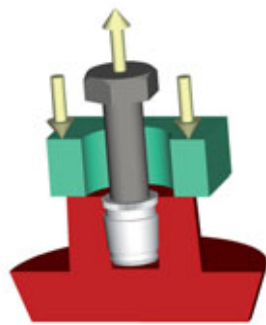

Pull-out strength (FA[N])

Technical notes

Indicated values are guide values. We recommend an installation test for the respective application. To be on the safe side, for fibre-reinforced plastics, the strengths of the non-reinforced material should be assumed. If you use brass thread inserts in plastics susceptible to stress cracks (e.g. polycarbonate), we recommend additional surface treatment of the thread inserts (nickel plating or surface coating as required). Strength values for other thread inserts on request.

The versions – thread inserts for self-tapping insertion QUICKSERT® Hex



The advantages

- Efficient installation process resulting from additional driver shape (e.g. hexagonal shape)
- For thermoplastics and thermosets
- Extra small flank angles of the special external thread minimise radial tensions
- High-strength and torsion-proof threads
- Special version available with external left-hand thread for improved reverse locking

Principle

QUICKSERT® Hex consists of a cylindrical basic body with internal thread and additional internal hexagon and a special external thread. The profile of the external thread has an extremely small flank angle and expands asymmetrically towards the thread root. This way, installation at low driving torques is optimised. Very good tight-fit is achieved with an ideal distribution of load. The bottom part of the bush is provided with a cutting slot. For special requirements, we offer a version with flange. The threaded bush is inserted and screwed in with a rotating spindle. It is not necessary to screw out the spindle.

Technical data

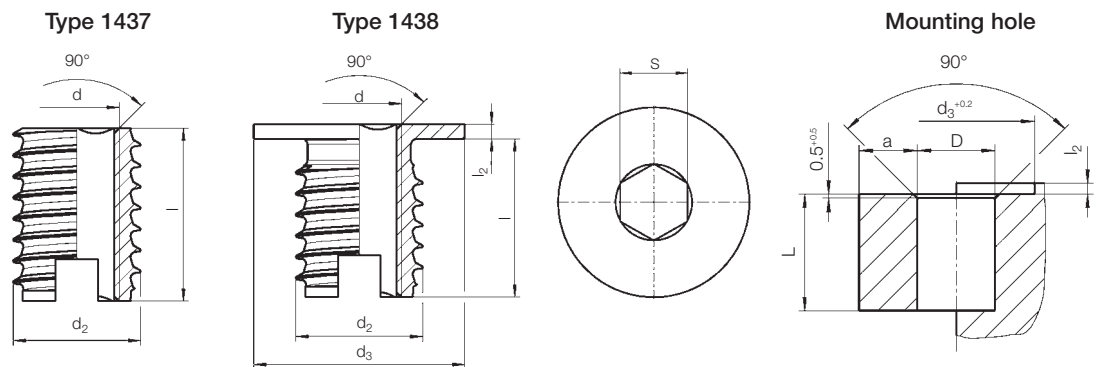

d	Brass, standard Order No	Brass, flange Order No	l	l ₂	d ₂	d ₃	L _{min.}	a _{min.}	S
M 4	1437 504 0008	1438 504 0009	8.0	1.0	7.0	10.0	9.0	3.0	3.2
M 5	1437 505 0010	1438 505 0112	10.0	1.2	8.0	11.0	11.0	4.0	4.0
M 6	1437 506 0014	1438 506 0154	14.0	1.4	10.0	13.0	15.0	4.0	5.0
M 8	1437 508 0015	1438 508 0164	15.0	1.4	12.0	15.0	16.0	5.0	6.5

Minimum quantity on request. All dimensions in mm.

For recommended mounting holes -D- for **QUICKSERT® Hex** in different materials® see table on page 20!

The versions – thread inserts for self-forming insertion **QUICKSERT® plus**



The advantages

- Suitable for thermoplastic parts
- High-strength and torsion-proof threads
- Chipless installation
- Special version available with external left-hand thread for improved reverse locking
- Material: Cu Zn 38 Pb 2 (EU 2000/53 compliant)

Principle

QUICKSERT® plus consists of a tapered basic body (8° overall taper) with internal thread, additional internal hexagon and a special external thread.

The profile of the external thread has an extremely small flank angle and expands asymmetrically towards the thread root. Driving torques for installation are thus reduced. Very good tight-fit is achieved with an ideal distribution of load. Since no cutting slot is required, there is no chip formation because the thread insert forms into the plastic material.

For special requirements, we offer a version with flange.

The threaded bush is inserted and screwed in with a rotating spindle.

Technical data

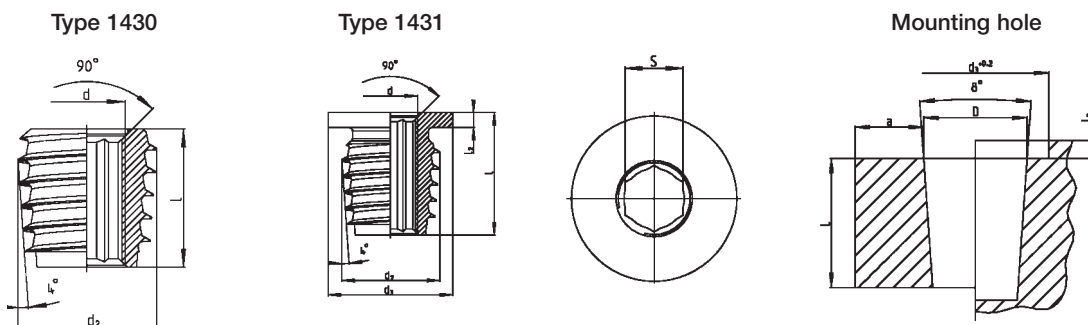

d	Brass Order No	D ^{+0.1} ⓐ	l	d ₂	L _{min.} ⓑ	a _{min.} ⓐ	S
M 4	1430 004 0008	7.10	8.00	7.74	8.00	5.00	3.20
M 5	1430 005 0009	8.20	9.00	9.15	9.00	5.50	4.00
M 6	1430 006 0011	9.50	11.00	10.70	11.00	6.00	5.00
M 8	1430 008 0014	11.90	14.00	13.69	14.00	7.05	6.50

d	Brass, with flange Order No	D ^{+0.1} ⓐ	l	l ₂	d ₂	d ₃	L _{min.} ⓑ	a _{min.} ⓐ	S
M 4	1431 004 0104	7.20	10.40	1.4	7.68	10.00	9.00	5.00	3.20
M 5	1431 005 0114	8.30	11.40	1.4	9.12	11.50	10.40	5.50	4.00
M 6	1431 006 0134	9.60	13.40	1.4	10.67	13.00	12.00	6.00	5.00
M 8	1431 008 0174	12.20	17.40	1.4	13.76	18.00	16.00	7.00	6.50

ⓐ Guide value – depends on moulding material, may have to be changed after setting trials.

ⓑ For blind hole L + 1 mm.

All dimensions in mm.

The versions – thread inserts for self-tapping insertion **QUICKSERT® plus**

Technical data

Driving torque values **QUICKSERT® plus M 5**

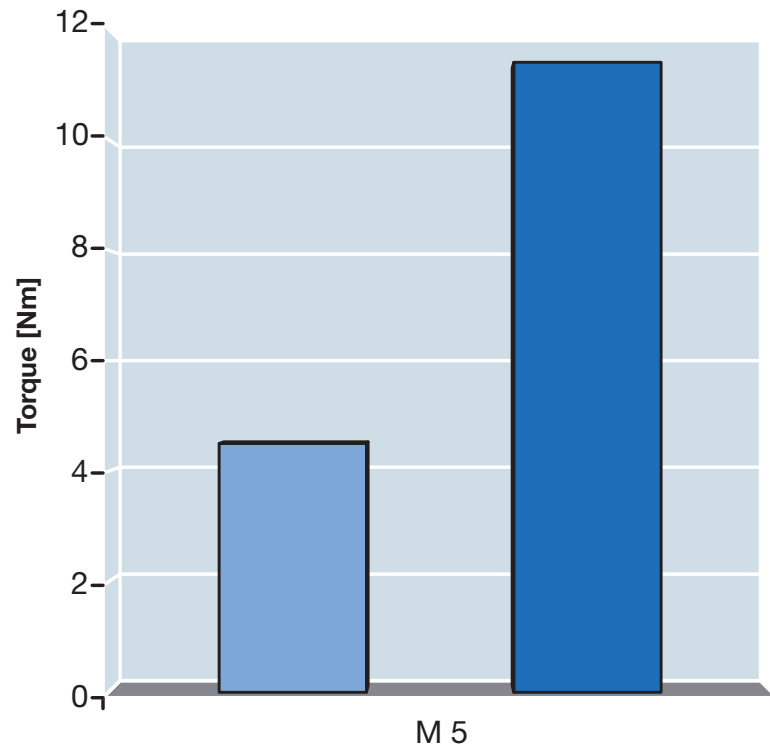

	M 5
■ PP ME [Nm]	4.5
■ PA 6 GF 30 ME [Nm]	11.4

Installation method thermal installation

Installation method self-tapping insertion

Installation method expansion anchoring

The versions – thread inserts for self-tapping insertion **QUICKSERT® plus**

Technical data

Pull-out values **QUICKSERT® plus M 5**

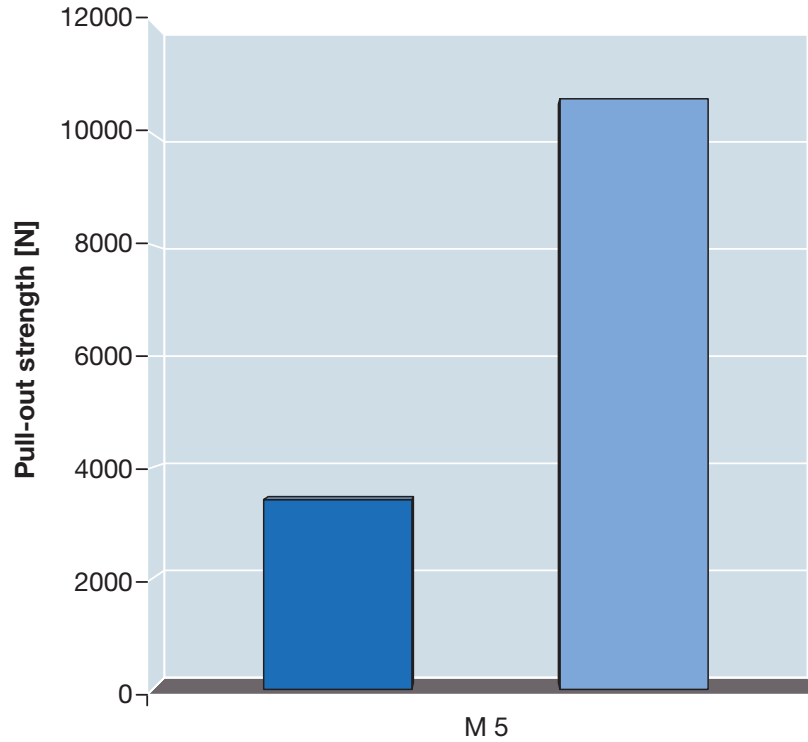

	M 5
■ PP FA [N]	3,417
■ PA 6 GF FA [N]	10,631

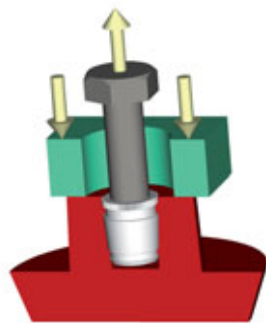

Pull-out strength (FA[N])

Technical notes

Indicated values are guide values. We recommend an installation test for the respective application. To be on the safe side, for fibre-reinforced plastics, the strengths of the non-reinforced material should be assumed. If you use brass thread inserts in plastics susceptible to stress cracks (e.g. polycarbonate), we recommend additional surface treatment of the thread inserts (nickel plating or surface coating as required). Strength values for other thread inserts on request.

The versions – thread inserts for self-tapping insertion **QUICKSERT®**

Installation tools – semi-automatic

QUICKSERT® self-tapping insertion

Adaptable to box-column drilling machines or cordless screwdrivers

■ For small to medium series

	QUICKSERT® Manual installation Order No
M 3	1450 010 3000
M 4	1450 010 4000
M 5	1450 010 5000
M 6	1450 010 6000
M 8	1450 010 8000
M 10	1450 011 0000



QUICKSERT®

Installation method thermal installation

Installation method self-tapping insertion

Installation method expansion anchoring

The versions – thread inserts for self-tapping insertion **QUICKSERT®**

Installation tools

QUICKSERT® self-tapping insertion

Pneumatic screwdriver

- High performance due to automatic reverse upon reaching the set torque
- Stationary operation due to adaptation to parallel guide
- Medium to large series



	Complete device Order No	Exchange unit Order No
M 3	1460 030 3000	1460 030 3050
M 4	1460 030 4000	1460 030 4050
M 5	1460 030 5000	1460 030 5050
M 6	1460 030 6000	1460 030 6050
M 8	1460 030 8000	1460 030 8050
M 10	1460 031 0000	1460 031 0050

Matching parallel guide 0182 060 0010

Parallel system type S

Type	Product characteristics		Order No
S 600	work radius	140 mm – 600 mm	0182 080 0003
	work height	50 mm – 430 mm	
	weight without tool	8 kg	
	torque absorption	15 Nm max.	

Delivery scope:

- 3-axis guiding system
- Tool holder
- 1 balancer 1 – 3 kg
- Base plate made of extruded aluminium profile with grooves, dimensions w x h x l: 240 x 40 x 500 mm

Type	Size	Order No
Service unit	at 6 bar nominal flow G 1/4" = 700 l/min	
Hose	inner diameter 6	0196 000 1130
Hose clip	8 – 12 mm	0196 000 1150
Hose liner	G 1/8"-6	0196 000 1151
Hose liner	G 1/4"-6	0196 000 1152
Exhaust air hose	Ø 15 mm	0196 000 1131

Advantages

- Rationalisation
- Quick and safe positioning
- Fatigue-free working
- No return rotation forces
- Compensation of screwdriver weight
- Easy handling
- Flexibility
- Can be used with electrical and pneumatic installation tools



- Quick retooling
- 360° rotatable
- Smooth and precise roller guides
- Optimum workstation layout

Installation method thermal installation

Installation method self-tapping insertion

Installation method expansion anchoring

The versions – thread inserts for self-tapping insertion **QUICKSERT® Hex**

Installation tools

QUICKSERT® Hex with flange and QUICKSERT® plus with flange self-tapping insertion, UNIQUICK® Basic telescopic screwdriver system with UNIQUICK® Feeder system
 ■ For large series (dimensions on request)



QUICKSERT® Hex with flange Self-tapping insertion UNIQUICK® Vario modular screwdriver system with UNIQUICK® Feeder system
 ■ For large series (dimensions on request)



QUICKSERT® Hex self-tapping insertion and QUICKSERT® plus

Manual mandrel for small series or adaptable to cordless screwdriver or pneumatic installation tool (type P-S 1216) for small to medium series.

	Order No
M 4	1467 020 5040
M 5	1467 020 5050
M 6	1467 020 5060
M 8	1467 020 5080



Type P-S 1216

For quick installation of **QUICKSERT® Hex and QUICKSERT® plus**

Technical data:

Speed without load: 950 min⁻¹ at p = 6.3 bar adjustable via air pressure
 Air consumption: 5,5 L/s at p = 6.3 bar
 Torque: M = 1.2 – 5.5 Nm steplessly adjustable shut-off clutch
 Tool holder: 1/4" hexagon socket with radial bearing
 Weight: 0.8 kg
 Order No: **4160 180 0010**

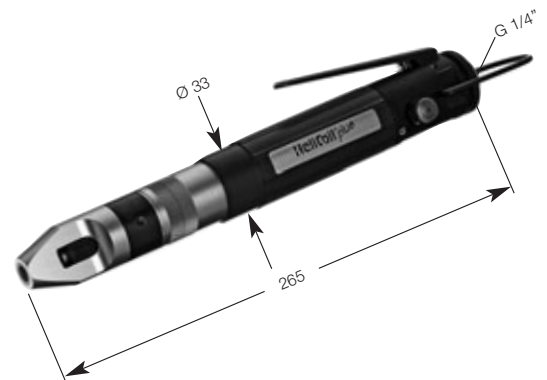

Installation method thermal installation

Installation method self-tapping insertion

Installation method expansion anchoring

The versions – thread inserts for expansion anchoring **Expansionsert 1**

Installation method thermal installation



The advantages

- Universal thread insert for thermoset and thermoplastic components
 - High-strength threads by expansion anchoring
 - Quick, cost-effective installation
- Material: Cu Zn 38 Pb 2 (EU 2000/53 compliant)

Principle

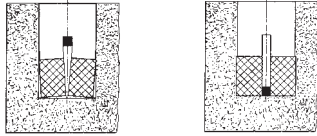

The **EXPANSIONSERT 1** thread insert consists of a cross-slotted basic body with internal thread, which has an external diamond knurl, and an spreader plate. When the thread insert is installed in the mounting hole, the diamond knurl part is expanded by the spreader plate which is pressed down. As a result, it is anchored in the wall of the hole.

Installation method self-tapping insertion

Technical data

Type 0230
EXPANSIONSERT 1 standard

Mounting hole[®]

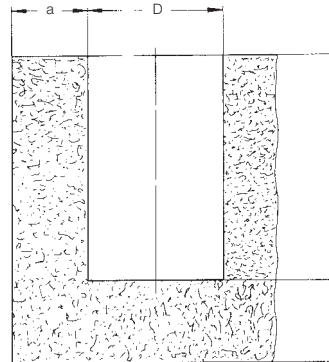
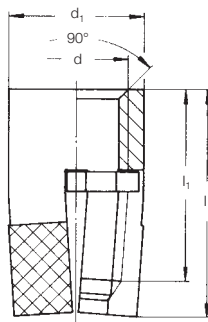

For installation tools and machines, see pages 39 – 40

d	Order No	d ₁	l	l _{1 min.}	D ^{+0.1} ®	L	a _{min.}	b _{min.}
M 2.5	0230 025 0065	4.0	6.5	4.0	4.0	6.5	2.4	3.2
M 3	0230 903 0001	4.0	6.5	4.0	4.0	6.5	2.4	3.2
	0230 003 0065	4.8	6.5	4.0	4.8	6.5	2.9	3.2
M 3.5	0230 035 0008	4.8	8.0	5.0	4.8	8.0	2.9	4.0
M 4	0230 004 0095	5.5	9.5	6.5	5.5	9.5	3.3	4.7
	0230 004 0008	5.5	8.0	5.0	5.5	8.0	3.3	4.0
M 5	0230 005 0011	6.5	11.0	7.5	6.5	11.0	3.9	5.5
	0230 005 0008	6.5	8.0	4.5	6.5	8.0	3.9	4.0
M 6	0230 006 0125	8.0	12.5	8.5	8.0	12.5	4.8	6.2
M 8	0230 008 0016	11.0	16.0	11.0	11.0	16.0	6.6	8.0

Metric ISO thread according to DIN 13-6H. Technical modifications reserved. Minimum quantity on request. All dimensions in mm.

® Guide values: depend on moulding material, may have to be changed after setting trials.

Other sizes and special designs on request.

Installation method expansion anchoring

The versions – thread inserts for expansion anchoring **Expansionsert 1**

Technical data

Type 0231[Ⓞ]
EXPANSIONSERT 1 flange

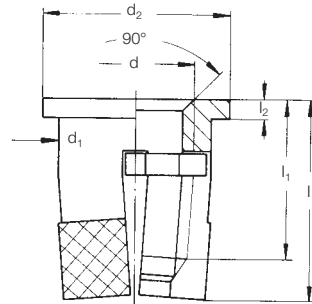

Mounting hole[Ⓞ]

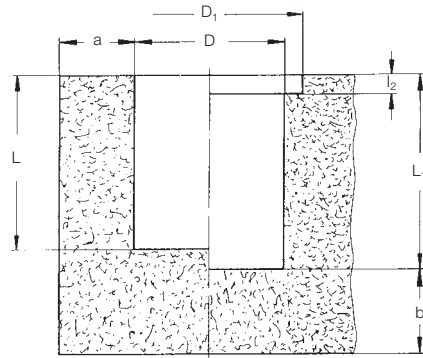

For installation tools, see pages 39 – 40

d	Order No	l	d ₁	d ₂	l _{1 min.}	l ₂	D ^{+0.1Ⓞ}	D ₁ ^{+0.2}	L	L ₁	a _{min.}	b _{min.}
M 2.5	0231 025 0006	6.0	4.0	5.5	3.6	0.8	4.0	5.5	5.2	6.0	2.4	3.2
M 3	0231 003 0006	6.0	4.8	6.3	3.5	0.8	4.8	6.3	5.2	6.0	2.9	3.2
M 3.5	0231 035 0075	7.5	4.8	6.3	4.7	0.8	4.8	6.3	6.7	7.5	2.9	4.0
M 4	0231 004 0075	7.5	5.5	7.0	4.4	0.8	5.5	7.0	6.7	7.5	3.3	4.7
M 5	0231 005 0085	8.5	6.5	8.0	5.0	0.8	6.5	8.0	7.7	8.5	3.9	5.5
M 6	0231 006 0011	11.0	8.0	10.0	7.0	0.8	8.0	10.0	10.2	11.0	4.8	6.2

Metric ISO thread according to DIN 13-6H.
Delivery conditions according to DIN 267.
Technical modifications reserved.
Minimum quantity on request.

[Ⓞ] Guide values: depend on moulding material, may have to be changed after setting trials.
The flange has a large contact surface and thus reduces surface pressure.

Other sizes and special designs on request.

Type 0232
EXPANSIONSERT 1 clinch

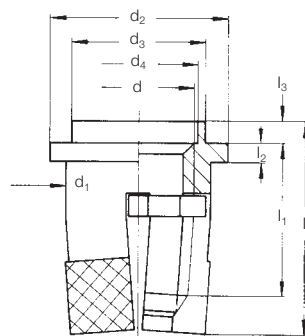

The clinched edge is designed to fasten contact components and cable eyes as well as to serve as a fixing aid for a cover part to be applied.

Mounting hole[Ⓞ]
(same dimensions as type 0231)

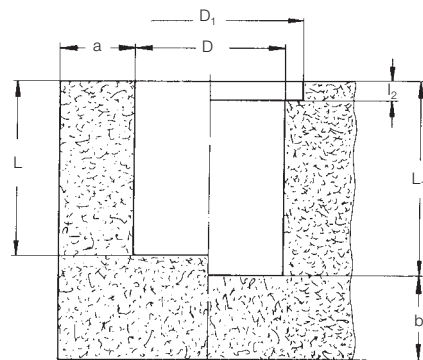

For installation tools, see pages 39 – 40

d	Order No	l	d ₁	d ₂	d _{3 max.}	d ₄	D ^{+0.1Ⓞ}	D ₁ ^{+0.2}	l _{1 min.}	l ₂	l ₃
M 2.5	0232 025 0007	7.0	4.0	5.5	3.6	2.8	4.0	5.5	3.6	0.8	1.0
M 3	0232 003 0007	7.0	4.8	6.3	4.1	3.3	4.8	6.3	3.5	0.8	1.0
M 3.5	0232 035 0085	8.5	4.8	6.3	4.6	3.8	4.8	6.3	4.7	0.8	1.0
M 4	0232 004 0085	8.5	5.5	7.0	5.1	4.3	5.5	7.0	4.4	0.8	1.0
M 5	0232 005 0095	9.5	6.5	8.0	6.1	5.3	6.5	8.0	5.0	0.8	1.0
M 6	0232 006 0012	12.0	8.0	10.0	7.1	6.3	8.0	10.0	7.0	0.8	1.0

Metric ISO thread according to DIN 13-6H. [Ⓞ] Guide values: depend on moulding material, may have to be changed after setting trials.
Technical modifications reserved.
Minimum quantity on request.
All dimensions in mm.

Other sizes and special designs on request.

The versions – thread inserts for expansion anchoring *Expansionsert 2*



The advantages

- For reactive resins, PUR, elastomers, integral hard foams as well as for wood composite materials
 - Wear-resistant threads
 - Quick, cost-effective installation
- Material: Cu Zn 38 Pb 2 (EU 2000/53 compliant)

Principle

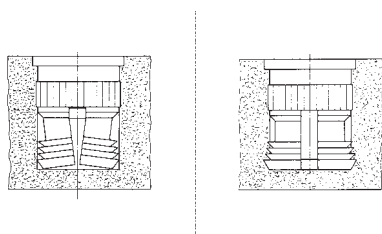

The **EXPANSIONSERT 2** thread insert consists of a body with internal thread, which has knurls and undercuts on the circumferential surface. Inside the body, there is a spreader plate that is pressed downwards when the thread insert is installed in the mounting hole. Upon installation, the slotted bottom part of the **EXPANSIONSERT 2** is expanded and its cutting rings are anchored in the wall of the mounting hole. The thread insert is thus reliably secured against pull-out and twisting.

Technical data

Type 0235

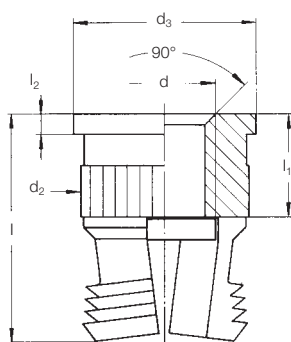

Mounting hole^①

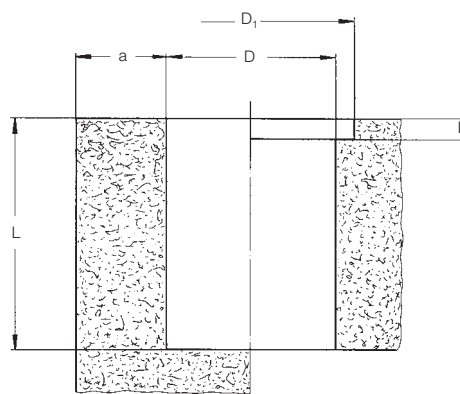

For installation tools and machines, see pages 39 – 40

d	Order No	l	d ₂	d ₃	l ₁	l ₂	D ^{+0.1} ^①	D ₁	L _{min.}	a _{min.}
M 3	0235 103 0008	8.0	5.9	7.0	3.0	0.8	5.5	7.2	8.2	4.0
M 3.5	0235 135 0008	8.0	5.9	7.0	3.5	0.8	5.5	7.2	8.2	4.0
M 4	0235 104 0095	9.5	6.9	8.0	4.0	0.8	6.5	8.2	9.8	5.0
M 5	0235 105 0011	11.0	8.4	10.0	5.0	0.8	8.0	10.2	11.3	6.0
M 6	0235 106 0125	12.5	8.4	10.0	6.0	0.8	8.0	10.2	12.8	6.0

Metric ISO thread according to DIN 13-6H.
 Technical modifications reserved.
 Minimum quantity on request.
 All dimensions in mm.

① Guide values: depend on moulding material, may have to be changed after setting trials.

Other sizes and special designs on request.

The versions – thread inserts for expansion anchoring SPREDSERT® 1



The advantages

- For thermoplastic parts
- Knurled flange and anchor rings ensure high degree of security against twisting and tensile load
- Screw locking

Material: Cu Zn 38 Pb 2 (EU 2000/53 compliant)

Principle

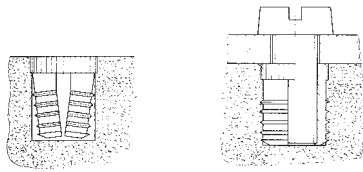

The **SPREDSERT® 1** is inserted into the mounting hole until the retaining flange is completely anchored in the plastic material. In that process, the slotted area is compressed. The radially secured **SPREDSERT® 1** is expanded by the screw so that the anchor rings penetrate the plastic material and ensure the tight-fit of the thread insert. In this process, the screw is locked. For the additional expansion force, the tightening torque must be increased by 10 %.

Technical data

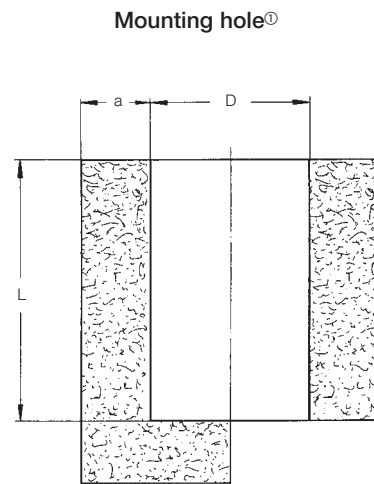
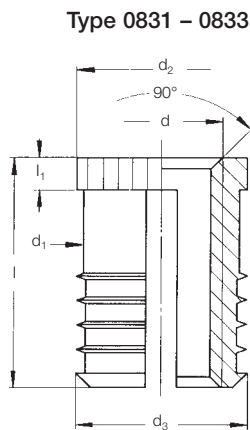

For installation tools and machines, see pages 39 – 40

d	Order No	Number of anchor rings	d ₁	d ₂	d ₃	l [Ⓢ]	l ₁	D ^{+0.1Ⓢ}	L _{min.}	a _{min.}
M 2	0832 102 0004	3	3.15	3.7	3.6	4.0	0.6	3.2	4.5	2.0
M 2.5	0832 125 0005	3	3.9	4.5	4.4	5.0	0.75	4.0	5.5	2.5
M 3	0832 103 0005	3	3.9	4.5	4.4	5.0	0.75	4.0	5.5	3.0
M 3.5	0832 135 0065	3	4.7	5.3	5.2	6.5	1.0	4.8	7.1	3.2
M 4	0833 104 0008	4	5.35	6.0	5.9	8.0	1.3	5.5	8.7	3.5
M 5	0833 105 0095	5	6.35	7.0	6.9	9.5	1.3	6.5	10.3	4.0
M 6	0831 106 0011	5	7.85	8.5	8.4	11.0	2.0	8.0	12.0	5.0
M 8	0831 108 0013	5	9.5	9.95	9.9	13.0	2.0	9.6	14.0	7.0

Metric ISO thread according to DIN 13-6H.
 Technical modifications reserved.
 Minimum quantity on request.
 All dimensions in mm.

Ⓢ Guide values: depend on moulding material, may have to be changed after setting trials.
 Ⓢ Screw contact length = min. insert length (l) + 1p (pitch)

Other sizes and special designs on request.

The versions – thread inserts for expansion anchoring SPREDSERT® 2

Installation method thermal installation



The advantages

- For thermoset parts
 - Knurled flange and diamond knurl ensure high degree of security against twisting and tensile load
 - Screw locking
- Material: Cu Zn 38 Pb 2 (EU 2000/53 compliant)

Installation method self-tapping insertion

Principle

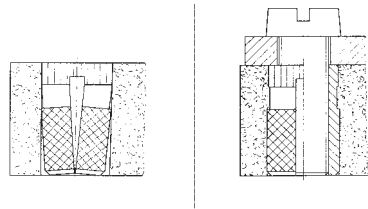

The **SPREDSERT® 2** is inserted into the mounting hole until the retaining flange is completely anchored in the plastic material. In that process, the slotted area is compressed. The radially secured **SPREDSERT® 2** is expanded by the screw so that the diamond knurling penetrates the plastic material and ensures the tight-fit of the thread insert. In this process, the screw is locked.

For the additional expansion force, the tightening torque must be increased by 10 %.

Installation method expansion anchoring

Technical data

Type 0837

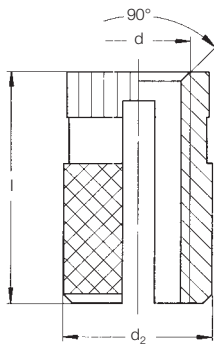

Mounting hole^①

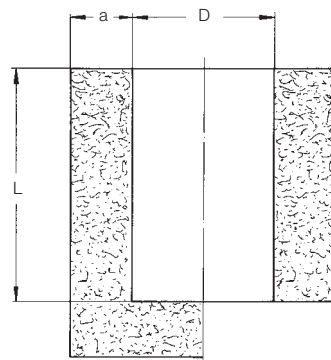

For installation tools and machines, see pages 39 – 40

d	Order No ^②	l ^③	d ₂	D ^{+0.1} ^③	L _{min.}	a _{min.}
M 3	0837 103 0005	5.0	4.3	3.9	5.5	3.0
M 3.5	0837 135 0064	6.4	5.1	4.7	7.0	3.3
M 4	0837 104 0008	8.0	6.0	5.5	8.5	3.5
M 5	0837 105 0095	9.5	6.8	6.3	10.0	4.0
M 6	0837 106 0127	12.7	8.4	7.9	13.5	5.0

Metric ISO thread according to DIN 13-6H.
 Technical modifications reserved.
 All dimensions in mm.

Other sizes and special designs on request.

① Guide values: depend on moulding material, may have to be changed after setting trials.
 ② Minimum quantity on request.

③ Screw contact length = min. insert length (l) + 1p (pitch)

The versions – thread inserts for expansion anchoring **SPREDSERT® 1 + 2**

Technical data

Torque values SPREDSERT® 1 + 2 / M 3 to M 8

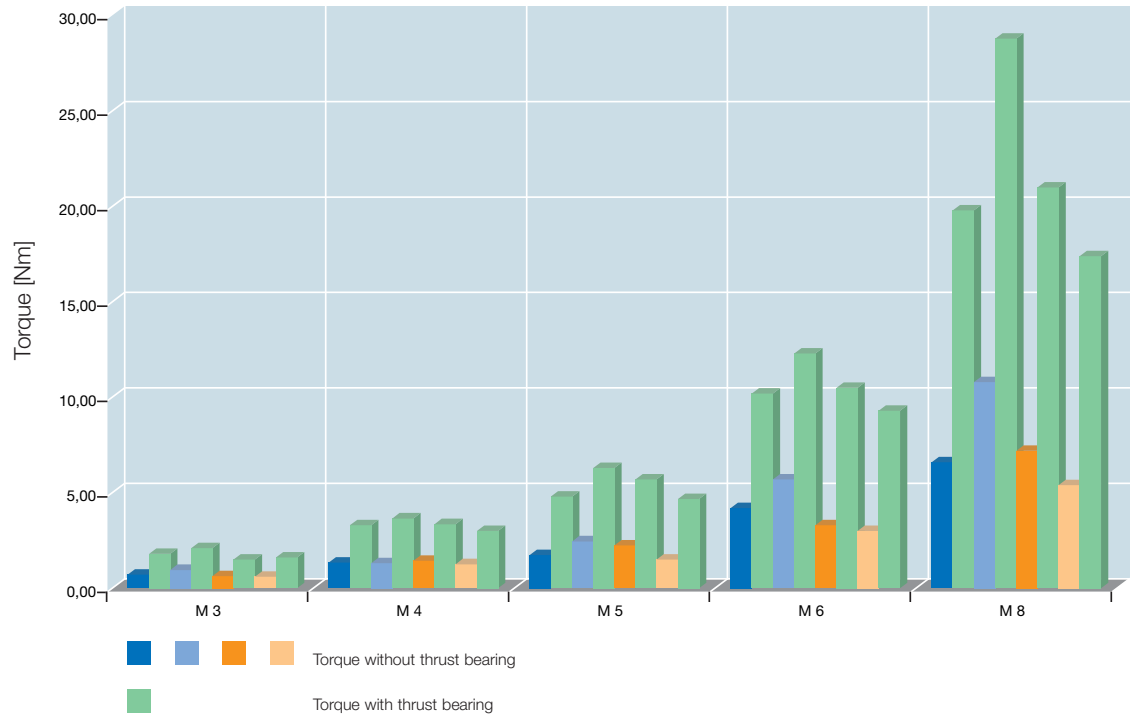

		M 3	M 4	M 5	M 6	M 8
■ ABS	MA [Nm]	0.72	1.35	1.74	4.20	6.60
■ ABS	MR [Nm]	1.80	3.30	4.80	10.20	19.80
■ PC	MA [Nm]	0.96	1.32	2.46	5.70	10.80
■ PC	MR [Nm]	2.10	3.66	6.30	12.30	28.80
■ PA	MA [Nm]	0.63	1.44	2.25	3.30	7.20
■ PA	MR [Nm]	1.50	3.36	5.70	10.50	21.00
■ PE/PP	MA [Nm]	0.60	1.26	1.50	3.00	5.40
■ PE/PP	MR [Nm]	1.62	3.00	4.68	9.30	17.40

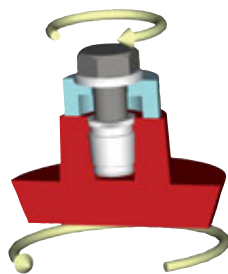

Torque without thrust bearing (MA[Nm])
(jack out)

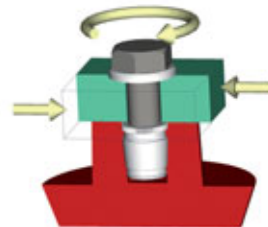

Torque with thrust bearing (MR[Nm])

The versions – thread inserts for expansion anchoring **SPREDSERT® 1 + 2**

Technical data

Pull-out values SPREDSERT® 1 + 2 / M 3 to M 8

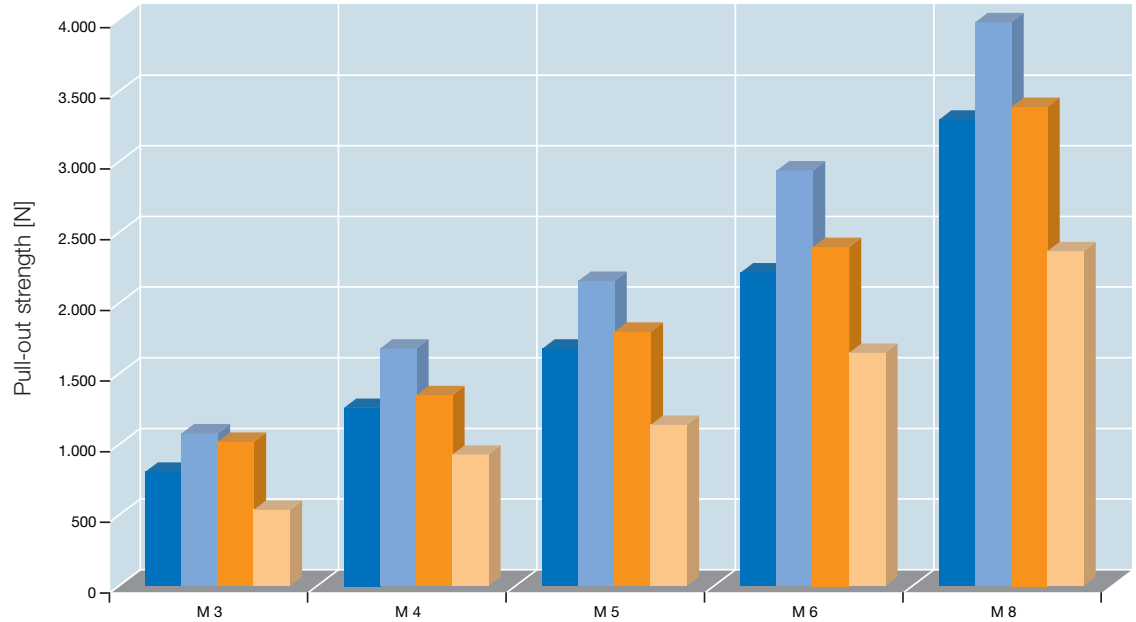

	M 3	M 4	M 5	M 6	M 8
■ ABS FA [N]	810	1,260	1,680	2,220	3,300
■ PC FA [N]	1,080	1,680	2,160	2,940	3,990
■ PA FA [N]	1,020	1,350	1,800	2,400	3,390
■ PE/PP FA [N]	540	930	1,140	1,650	2,370

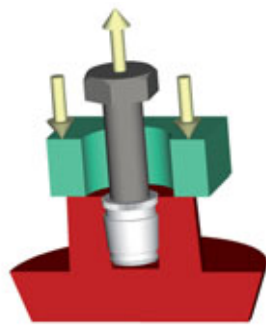

Pull-out strength (FA[N])

Technical notes

Indicated values are guide values. We recommend an installation test for the respective application. To be on the safe side, for fibre-reinforced plastics, the strengths of the non-reinforced material should be assumed. If you use brass thread inserts in plastics susceptible to stress cracks (e.g. polycarbonate), we recommend additional surface treatment of the thread inserts (nickel plating or surface coating as required). Strength values for other thread inserts on request.

The versions – thread inserts for expansion anchoring SPREDSERT® with retaining flange

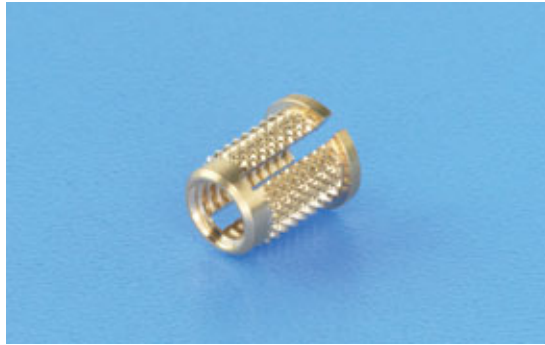

The advantages

- For thermoset and thermoplastic components
 - High-strength threads in through holes
 - Screw locking
- Material: Cu Zn 38 Pb 2 (EU 2000/53 compliant)

Principle

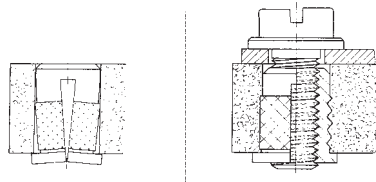

The **SPREDSERT®** with retaining flange is inserted into the through hole until the retaining flange is seated. The slotted anchoring section with diamond knurl is compressed.

By screwing in the screw, the thread insert is forced open in the anchoring section so that the diamond knurling penetrates the plastic material. The retaining flange which acts as a shoulder support ensures high pull-out locking while the screw is also locked. For the additional expansion force, the tightening torque must be increased by 10 %.

Technical data

Type 0835

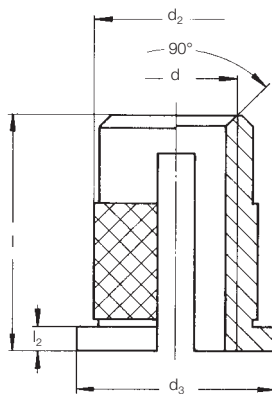

Mounting hole^①

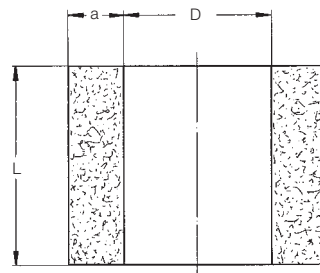

For installation tools and machines, see pages 39 – 40

d	Order No	l ^①	d ₂	d ₃	l ₂	D ^{+0.1①}	L _{min.}	a _{min.}
M 3	0835 103 0048	4.8	4.3	5.5	0.5	3.9	4.5	3.2
M 3.5	0835 135 0064	6.4	5.1	6.3	0.7	4.7	6.0	3.6
M 4	0835 104 0008	8.0	6.0	7.0	0.8	5.5	7.5	4.0
M 5	0835 105 0095	9.5	6.8	8.0	1.0	6.3	9.0	4.8
M 6	0835 106 0127	12.7	8.4	9.5	1.3	7.9	12.0	6.0
M 8	0835 108 0127	12.7	9.9	11.0	1.3	9.4	12.0	7.1

Metric ISO thread according to DIN 13-6H.
 Technical modifications reserved.
 Minimum quantity on request.
 All dimensions in mm.

① Guide values: depend on moulding material, may have to be changed after setting trials.
 ② Screw contact length = min. insert length (l) + 1p (pitch)

Other sizes and special designs on request.

The versions – thread inserts for expansion anchoring QUICKSERT® Expansion type 1230

Installation method thermal installation



The advantages

- No tapping
- Quick, cost-effective installation
- Chipping-free installation in smooth mounting holes
- High-strength threads in light metals
- High-strength threads in thermoplastic and thermoset components** after moulding of components
- Suitable for one-sided accessibility of the installation point
- For screwed connections that can be detached as often as required
- For installation on finished surfaces

Material: 11 SMn Pb 30+c

Surface: A2J ISO 4042 Cr (VI)-free
or Cu Zn 38 Pb 2 (EU 2000/53 compliant)

Installation method self-tapping insertion

Principle

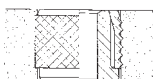

The **QUICKSERT® Expansion** is spun on to the rotating threaded mandrel of the installation tool and introduced into the mounting hole. The hole can be preformed or machined with common drills as a blind or through hole. The axial pulling motion of the threaded mandrel causes the **QUICKSERT® Expansion** to shear at the predetermined breaking point between anchoring sleeve and threaded bush. The threaded bush is pulled into the anchoring sleeve and expands it. Meanwhile, the diamond knurl of the anchoring sleeve is pressed into the wall of the hole. The thread insert is now anchored and locked against screwing and pull-out.

Installation method expansion anchoring

Technical data

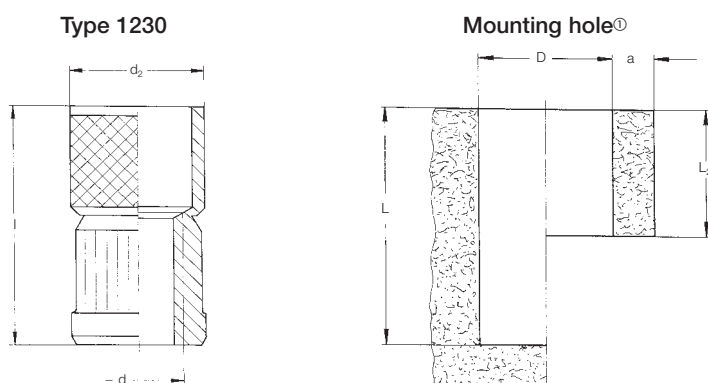

For installation tools and machines, see pages 39 – 40

d	Steel Order No	Brass Order No	Total length l	Total length installed l ₁	Knurls ø d ₂	Mounting hole			
						D ^{+0.10}	L _{min}	L _{2min}	a
M3	1230 003 0048	1230 103 0048	8.0	4.8	5.5	5.5	8.8	4.8	2
M4	1230 004 0063	1230 104 0063	10.5	6.3	6.5	6.5	11.8	6.3	2
M5	1230 005 0082	1230 105 0082	13.5	8.2	7.5	7.5	15.2	8.2	2.5
M6	1230 006 0098	1230 106 0098	16.0	9.8	9	9	18.8	9.8	3
M8	1230 008 0 115	1230 108 0 115	19.0	11.5	12	12	21.0	11.5	4

Minimum quantity on request. All dimensions in mm.

For installation into plastic, we recommend brass thread inserts. Special lengths and thread diameters as well as other materials on request.

① Guide values: depend on moulding material, may have to be changed after setting trials.

** Particularly test this insert for suitability for plastics susceptible to stress cracks (e.g. PC, PPO).

The versions – thread inserts for expansion anchoring

Installation tools – manual installation tools

EXPANSIONSERT 1, EXPANSIONSERT 2, SPREDSERT® 1 and 2

Assembly mandrels for manual installation of **EXPANSIONSERT 1**, **EXPANSIONSERT 2** thread inserts

	EXPANSIONSERT 1 Standard Order No	EXPANSIONSERT 1 Flange/Clinch Order No	EXPANSIONSERT 2 Order No	SPREDSERT® Order No
M 2.5	0250 025 0065	0253 025 0006	–	0851 125 0000
M 3	0250 003 0065	0253 003 0006	0254 103 0008	0851 103 0000
M 3.5	0250 035 0008	0253 035 0075	–	0851 135 0000
M 4	0250 004 0095	0253 004 0075	0254 104 0095	0851 104 0000
	0250 004 0008	0253 004 0075	0254 104 0095	0851 104 0000
M 5	0250 005 0011	0253 005 0085	0254 105 0011	0851 105 0000
	0250 005 0008	0253 005 0085	0254 105 0011	0851 105 0000
M 6	0250 006 0125	0253 006 0011	0254 106 0125	0851 106 0000
M 8	0250 008 0016	–	–	0851 108 0000



Installation method thermal installation

Semi-automatic tools

EXPANSIONSERT 1, EXPANSIONSERT 2

The tool can be integrated into manual lever presses or other pressing devices.

■ For small to medium series



Example of a tool application



**EXPANSIONSERT 1,
EXPANSIONSERT 2**

Installation method self-tapping insertion

	EXPANSIONSERT 1 Standard Order No	EXPANSIONSERT 1 Flange/Clinch Order No	EXPANSIONSERT 2 Order No	Semimatic Order No
M 2.5	–	0263 025 0006	–	–
M 3	0260 003 0065	0263 003 0006	0264 103 0008	1460 020 3050
M 3.5	0260 035 5008	0263 035 0075	0264 103 5008	–
M 4	0260 004 0095	0263 004 0075	0264 104 0095	1460 020 4050
	0260 004 0008	0263 004 0075	0264 104 0095	1460 020 4050
M 5	0260 005 0011	0263 005 0085	0264 105 0011	1460 020 5050
	0260 005 0008	0263 005 0085	0264 105 0011	1460 020 5050
M 6	0260 006 0125	0263 006 0011	0264 106 0125	1460 020 6050
M 8	–	–	–	1460 020 8050
M 10	–	–	–	1460 021 0050

Installation method expansion anchoring

The versions – thread inserts for expansion anchoring **QUICKSERT® Expansion**

Installation tools – QUICKSERT® Expansion
Machine installation tools with hydraulic-pneumatic drive

Setting tool P 2005 allows quick and safe installation.

■ For medium to large series

Order No 2361 550 6000

Designation	Order No
Threaded mandrel	2361 13x x020
Nosepiece	2361 13x x030

xx = metric dimension, M 3 to M 8 available.
 Example: M6 = 06 for QUICKSERT® M6.



Installation method thermal installation

Installation method self-tapping insertion

Installation method expansion anchoring

Fields of application

AMTEC® thread inserts are used in most diverse fields:

- Automotive industry
- Electrical and electronic engineering
- Railway industry
- Agricultural machinery engineering
- Construction machinery engineering
- Mechanical engineering
- Medical engineering
- Heating, air conditioning, ventilation systems
- and many more



AMTEC® examples of application ...

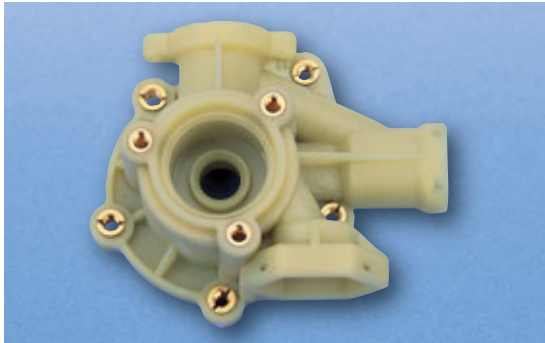

Pump casings, **HITSERT® 2** M 5 and **SPREDSERT®** with retaining flange M 6



Pump casings, **HITSERT® 2** bolts M 6 and compression limiters

... and customer-specific solutions



QUICKSERT® Expansion
Expansion insert with collar/steel



EXPANSIONSERT 1
with hexagon flange/brass



HITSERT® 3
Seal insert hose coupling/brass



Customer-specific special part, silvered



HITSERT® hose coupling with temperature-resistant O-ring



HITSERT® seal thread insert



SONICSERT® compression limiter with captive screw



Thread inserts for in-moulding?

IMTEC® moulded inserts meet the demands of the continuous further development in the field of technology. Progress has led to constantly increasing requirements for components and respective applications. In many cases, those requirements are so high, that they cannot be fulfilled with one material. Therefore, combining specific advantages of different materials is of particular interest. Combinations of metal and plastics provide advantages such as reduced weight, improved corrosion resistance and component cleanliness. Hence, in many fields of application, in-moulding of metal fasteners with plastics is the solution. As an expert in the field of joining technology, Böllhoff has detected the advantageous synergy effect of highstrength metals in combination with plastics and has included thread inserts for in-moulding in its product portfolio. These innovative IMTEC® moulded inserts are particularly suitable for thermoset and thermoplastic materials.



IMTEC® CO

- Maximum usable thread length
- Corrosion and acid resistance
- Increased technical cleanliness (residual dirt minimisation)
- High extraction force due to an optimisation of flank covering in plastics
- Weight reduction of the component

The IMTEC® CO thread insert for in-moulding is an asymmetric rolled stainless steel A2 (option A4) wire which is mainly used for customer components with blind hole threads. That wire is coiled to form a fixed bushing with at least one flange-type extension. In the forming process, the fasteners are also sufficiently magnetised and can be placed on magnetic core pins.

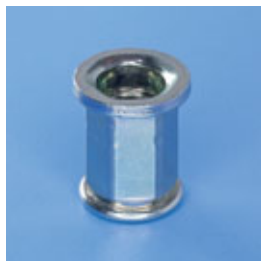

IMTEC® CF

- Very large flange diameters possible
- Deformation area for length adjustment of the insert; close length tolerances $< L \pm 0.05 \text{ mm}$
- Torque resistance by hexagonal design or knurls
- Pull out resistance by providing significant under cuts
- No metal-cutting operation
- Also feasible as compression limiter

The IMTEC® CF thread inserts with “double flange” are produced from steel by cold forming. The in-moulding technology requires particularly accurate thread inserts. The deformation area on the IMTEC® CF allows precisely adjusting the length of the thread insert. Upon closing, the parts of the mould compress the IMTEC® CF and precisely adjust the length of the component ($L \pm 0.05 \text{ mm}$). IMTEC® CF is primarily intended for components with through hole threads.



Adhesion of fasteners?

The **ONSERT®** technology allows adhesion of most diverse fasteners to diverse materials. Connection can be realised on ribs and surfaces.

- Works on plane surfaces
- No projection on the remote side
- Fastening elements do not become apparent on the visible side through heat input during laser welding or brazing
- Very good mechanical properties; shock absorbing
- Connection on fibre composites, coated surfaces, glass and plastic

Böllhoff International with companies in:

Argentina
Austria
Brazil
Canada
China
Czech Republic
France
Germany
Hungary
India
Italy
Japan
Mexico
Poland
Romania
Russia
Slovakia
Spain
Turkey
United Kingdom
USA

Apart from these 21 countries, Böllhoff supports its international customers in other important industrial markets in close partnership with agents and dealers.



Made of paper certified with the Ecolab of the European Community (Reg No. FR/11/003).
Printed by FSC®-certified company GFA-COC-001790.

Subject to technical change.
Reprinting, even in extract form, only permitted with express consent.
Observe protective note according to DIN 34.

Böllhoff Group
Please find your local contact on www.boellhoff.com
or contact us under fasteningtechnology@boellhoff.com

